

CRUISE REPORT NO. 90
OF PE/CK.4

PRELIMINARY DRAFT

CRUISE REPORT

BASELINE STUDY FOR COASTAL MANAGEMENT
REEF, BEACH, AND LAGOON NEAR RAROTONGAN HOTEL
RAROTONGA, COOK ISLANDS

CRUISE CK-84-1

21 MAY TO 12 JUNE 1984

By

RALF CARTER

And

JAN-ERIK STEEN

PREPARED FOR:

COMMITTEE FOR CO-ORDINATION
OF JOINT PROSPECTING FOR MINERAL
RESOURCES IN THE
SOUTH PACIFIC OFFSHORE
AREAS (CCOP/SOPAC)
WORK PROGRAM CCOP/CK.4

AS A CONTRIBUTION BY:

UNDP PROJECT RAS/01 102
POTENTIAL OF SOUTH PACIFIC
AND THE SOUTH PACIFIC
REGIONAL ENVIRONMENTAL
PROGRAM (SPREP), SOUTH
PACIFIC COMMISSION

BASELINE STUDY FOR COASTAL MANAGEMENT
REEF, BEACH, AND LAGOON NEAR RAROTONGAN HOTEL
RAROTONGA, COOK ISLANDS
21 MAY TO 12 JUNE 1984

INTRODUCTION AND BACKGROUND

This cruise was undertaken as a part of the CCOP/SOPAC work programmes, CCSP/CK.4 (Study of Sediments and Sedimentary processes of the beach, lagoon and adjacent offshore areas of Rarotonga and other islands to assist with Coastal Management programmes) in cooperation with the South Pacific Regional Environmental Programme.

Rarotonga has a tropical climate. Summer is November throughout March and winter is April through October. South East trade winds occur during the winter season. Winds are generally 6 to 14 knots. Calm occurs about 18 percent of the time, and winds in excess of 37 knots can be expected once a year. Temperature varies from 21 deg to 27 de Celsius. The central area is mountainous with peaks to 653 meters in elevation. A 0.75 km wide 32km long terrace of 3 to 50 meters in elevation surrounds the mango shaped islands. The average annual rainfall on the east end of the islands is 1840 mm which increased to a maximum of 4000 mm near the center of the islands and decreased to 2000 mm along the northwest terrace. The New Zealand Meteorological Services reports a mean rainfall of 2028 mm +/- 394 mm at Lat 21 11 S and Long 159 48 W at elevation of 7m, the maximum rainfall of 249 mm occurred in January and the minimum of 97 mm occurred in July (Coulter and Hessel 1980)

The Rarotongan Hotel is located on a small sand projection at the southwest part of Rarotonga. It was begun in 1975, opened in 1977, and by 23 November 1978 records indicates beach erosion problems. The coconut log groine was built in 1979 to control alongshore sand drift. During a storm in November 1982 the 150 room hotel experienced some seawater damage and a rock seawall was constructed at an average rate of just over 2 metres per year (Dorell 1984). The coast line is now eroded to within five meters of the eastern block of rooms.

CRUISE OBJECTIVES

The present study was conducted to develop baseline data on ocean processes that contribute to the beach erosion in the vicinity of the Rarotonga Hotel, estimate the degree of exposure

to action by the sea, and recommend alternative action that can provide various levels of protection.

Due to the urgency of the situation the recommendation will be based upon available data and limited to site observations during a single visit. Future work will be considered: however, immediate action is indicated.

PERSONNEL PARTICIPATION

Ralf Carter, Marine Scientist assisted by Jan-Erik Steen, Marine Scientist both from CCOP/SOPAC staff in Fiji conducted the study. They has supported and assistance of the Prime Ministers Department and the Ministry of Internal Affairs. Individuals giving direct assistance or participating in the study included:

Mr. Stuart G. Kingan, Scientific Research Officer
Mr. Tony Utonga, Secretary, Internal Affairs
Mr. Mike Mitchell, Solicitor General
Mr. O Peyrous, Registered Surveyor
Mr. R P Brill, Senior Surveyor
Mr. P Hauoli Smith, General Manager Rarotongan Hotel
Mr. D. E. Dorrell, Governing Director, Marine Construction
Mr. Vaitoti Tupa, Conservation Officer, Internal Affairs
Mr. Rongo Short, Surveyor
Mr. Tere Okirua, Assistant
Mr. Aturangi Hosking, Draughtsman
Mr. Paul Frost, Officer in Charge Meteorological Office
Mr. Ken Brown, Director Water Supply, Ministry Works
Mr. John Short, Contractor
Mr. Justin De Silva, Surveyor (PWD)
Mr. Altan Raymond Watters, Marine Zoo
Mr. GERALD McCormack, Education Department
Mr. Jason Brown, Reporter

METHODS, EQUIPMENT AND FACILITIES

The Rarotongan Hotel Site survey was based on the Survey Department existing control for the area. Horizontal position and orientation is based on the Main Road control traverse from S.O.314. Coordinates are thus in terms of the Rarotonga Initial, C.B.I. A “false origin” of +2000mN has been added to all coordinates to keep them positive and ambiguous. Heights are based on B.M.12 and are in terms of Mean Sea Level as determined in May 1951.

A closed traverse along the beach forms the basis for this survey, extended to the west by a single “Hanging Line” (1P11A). From the traverse, profiles of the beach have been run generally at right angles to the traverse and at 10 m intervals. A further stadia fix has been made of an offshore coral rock patch and the sand patch in the east.

Levels have been run along survey marks and taken on the profiles at each change of grade. All points fixed by stadia

have an additional level check placed on them.

Position accuracy of the traverse stations should be +/- 0.05 m; that of positions fixed by stadia +/- 0.5m; and profile points about +/- 1m. Vertical accuracy of traverse stations +/-0.02m with other levelled points +/- 0.05m.

A contour map showing the results of the present and previous surveys of the beach and lagoon areas was prepared. Critical profiles have been presented to show the rate of erosion.

An analysis of storm data for Rarotonga and some observation made during specific storms were used to develop design parameters. Samples of beach sand were collected for characterisation. Local rock was collected for evaluation of apparent density. These data were then employed to develop alternate coastal protection schemes.

The following equipment was provided by CCOP/SOPAC:

- Sextant
- Compass
- Hand level and Rod
- Tools, Sampling Equipment and Miscellaneous items

The facilities and equipment supplied by the Cook Island Government were:

- Equipment storage facilities
- Ground transportation, truck and Automobile
- Various maps, charts, photos, etc

RESULTS OF STUDY

Tropical Cyclones and Winds

Data compiled by Kerr (1976) and Revell (1981) indicated that during the 40 year period, 1939 – 1979 the South Pacific Ocean averaged 9.1 tropical cyclones per season. The coefficient of variation for the average was 32 percent. The peak occurrence of storms is between January and February. Analysis of the 91 South Pacific cyclones reported between 1969 and 1979 show the geometric mean wind speed for the 50 year recurrence interval to be 88 knots. The wind speed for the 50 year recurrence interval (R) was found to fit the relationship

$$Sc = A + B \text{ LOG } R$$

Where c was found to be 1.899061288, A was 1420.203802, B was

2046.05048 and S is in knots. The value of “A” was found to vary with both latitude and longitude of a particular location and its value for the Rarotongan was estimated to be 1456.265075.

The 1982 AID report describes the Southern Cook Islands was being at the edge of “hurricane corridor” of the South Pacific. Analysis of the above 91 tropical cyclones show Southern Cook Islands to experience 0.49 cyclones per year period. Hence, the 50 year design cyclone for the Southern Cook Islands is expected to have a sustained wind speed of 889 knots. The wind speed for storms having other recurrence intervals is:

Years	knots	years	knots
1	46.3	30	77.7
5	66.4	33	85.0
10	73.5	40	87.2
15	77.4	45	88.0
20	80.1	50	88.0
25	82.1	100	93.7

Winds in excess of 20 knots, exclusive of cyclones and observed at the Rarotonga airport, can be expected to have the following annual frequency:

Years	Frequency	knots	frequency
22	88	37	1.0
24	39	38	.8
26	20	40	.5
28	11	42	.3
30	6	44	.2
33	3	46	.15
34	2	48	.11
37	1.2	50	.08

The southern Cook Islands experienced 5 notable storms between 1905 and 1939 and 14 storms between 1940 and 1979. These data suggest that a serious storm can be expected every 5 to 6 years. Of the 19 storms between 1939 and 1979 13 had maximum impact from the North West, 4 from the north east, one east west and one looped passed the area. It should be noted that the impact the reef area and beach near the Rarotongan Hotel hence, some 75 percent of the storms that approached Rarotonga will have significant impact on this area. It should be noted that after a cyclone has passed the seas generated by the weak side of the island as the cyclone has passes. Therefore, all will large storms that pass close by can be expected to have some impact upon the reef area about the island.

It is of interest to investigate the cyclone that occurred in 1967 as the storm was known to rise 1.94 m above mean sea level during the passing of the storm. The meteorological

service recorded the following: "A tropical cyclone which developed east of the Ellice Islands moved slowly eastward towards the Northern Cook Islands, turned south-eastwards on 16 December and passed to the north of Palmerston 1. On the afternoon of the 17th. During the night it moved quite rapidly between Aitutaki and Rarotonga and by midday on the 18th was between Mauke and Mangaia.

On Palmerston 1. Several lighters and boatsheds were wrecked: and the high winds and heavy seas that pounded Aitutaki left boulders strewn across the road.

At Avarua in Rarotonga the storm demolished the agriculture building at Avarua wharf, two cinemas, the Union steam ship badly damaged the Rarotongan Hotel, many houses and bridges, and added to the havoc. Fortunately the cyclone was now moving fairly rapidly but it caused further damage in Mangaia as it passed close by.

Palmerston 1. Aitutaki and Mangaia all reported estimated winds of hurricane force at the peak of the storm but judging by the amount of damage reported it seems likely that the wind did not exceed force 9 or 10. The strongest measured wind speed at Rarotonga (10 minute average) was 42 knots with a peak gust speed of 81 knots. These winds were from the south when the centre of the storm was northwest of Rarotonga. Extreme turbulence induced by the range of hills behind Avarua undoubtedly contributed much to the extent of the damage. The Mariposa and another vessel rode out of the storm north of its track in the hurricane force winds. The two ships and Rarotonga all recorded lowest pressure below 975mb.

In passing it should be noted that during the storm both vessels master reported that at one time the vessels has rolled on their sides and then righted,

Storm Surge

The speed of the above cyclone was about 10 knots when it passed. Rarotonga some 66 nautical miles to the southwest of its centre. As the depth of the water near Rarotonga is on the order of 4000+ m, the celerity of the storm wave would be much in excess pressure would occur during maximum storm surge, the rise in water level would be 0.405 m due to change in barometric pressure Rarotonga is in the order of one meter. As much as 0.5 could be due to the tide leaving about one meter due to the wind and the wave action. The wind action would be less than .01 m due to the very steep approach to the islands; hence, the wave setup would be on the order of one meter. Using the method developed by the Corp of Engineers and hydraulic model data by Seeling (1983) an estimate of 0.8 was obtained. It was assumed that the wave was entering the harbor at Avarua was generate by a 22 year storm

over a fetch of 20 nautical miles giving a deep water wave height of 5.88 at 9.1 seconds with a wave of 130m.

The 42k gale forces winds recorded at the airport represents over land wind some 66 nautical miles from the centre of the cyclone. The maximum winds would be found on the other side of storm centre and they would be significantly greater than 42k. The storm probably represented a storm having a 20 to 25 year occurrence interval with maximum winds of 81 knots.

As shown above, the maximum wind speed on Rarotonga is on the order of 37k and the predicted annual cyclonic wind speed is 46.3 knots. The annual wind predicted annual cyclonic wind speed 46.3 knots. The annual wind speed is for a specific 10 nautical mile wide strip within a given 5 degree square area of ocean that includes island. Using the larger are for design of structure at a specific location would appear to be conservative. However the cyclone data collected between November 1969 and April 1979 is for ten seasons only and until additional satellite data is acquired and analysed a less conservative value is not warranted.

Sea, swell and Sand Transport

The recurrence of storms seas* at the reef are:

Years	H	T	L	Years	H	T	L
5	4.66	8.2	105	30	6.10	9.3	134
10	5.24	8.7	117	35	6.22	9.4	137
15	5.58	8.9	124	40	6.40	9.5	140
20	5.79	9.1	128	45	6.40	9.5	140
25	5.97	9.2	132	50	6.49	9.5	141

 *H is the significant wave height (m), T is period (sec) and L is wave length (m)

There is little available swell information for the Cook Islands. However, during the winter months swells producing 4 m high breakers on the reef and having periods of 10 to 15 seconds appear to happen frequently. Such well conditions do not impact the beach to the same extent as local storm. The swell is a more regular wave than that of the storm and as a result of the regularity it is more efficient in raising the wave setup water level that produces the sea return in the lagoon. Hence, strong along shore currents can be associated with the swell.

The trade wind generated over the reef flat would be a shallow water wave. The typical wave would be produced by a 10k southeast wind over a 612m fetch of 1.2 meter average water depth. This wave would be on the order of .1m in the height and have a 1 second period. It would approach the beach at an angle of about 30 degrees. During low tide at this location on 30 May 1984

a 6cm wave with a 1 second period was generated by a 5k wind over a 300m fetch.

An analysis of the upper-level, 900mb high wind frequencies which were reduced to 10 meter elevation was made using:

$$U_z/U_s = \ln(Z/Z_o)/\ln(10/Z_o)^2$$

Where Z_o is .2 to .5cm over waves at 10 meter height for light winds and .6cm for strong winds, U_z is the wind speed at 900m, Z is 900m and U_s is the wind speed at 10 meter elevation (handbook of Ocean and Underwater Engineering page 12-12). Wind data for Rarotonga from 1958 to 1979 and the trade wind generated waves over a .33 nautical mile of 1.2 average depth water are:

N	7	21	49	19	4	1	0	102
NE	12	29	91	34	5	1	0	173
E	10	33	147	96	12	2	0	300
SE	15	34	81	26	4	1	4	160
S	7	18	27	3	0			55
SW	10	15	26	5	1	0		58
W	7	12	32	13	3	1	0	68
NW	10	16	35	16	4	1	0	83
Sum	78	178	488	212	34	7	1	calm 2

The above winds generate the following waves over the reef flat:

Wave						
SEC	.51	.75	1.12	1.38	1.59	1.77
CM	1.8	3.96	9.75	15.24	21.03	26.21

The above waves can produce the following alongshore sand transport:

Sediment transport, cubits meters per day						
20deg.	.0014	.0750	10.87	34.02	17.97	8.09
40deg	.0021	.1312	19.10	68.03	26.96	12.50

This transport rate assumes an average sand size of .75mm, and the values are approximately only, the two decimal places are to aid in calculation and plotting.

Secondary Reef Wave

Another type of wave would be generated when large seas or swell break upon the reef. Roberts (1980) has shown that between 68 and 92 percent of the wave energy is lost by breaking at the reef during high tide and 77 and 97 percent can be lost during low tide. However such waves do cause secondary waves to form over the reef and the secondary waves can transport sand along the beach. Roberts gives the expression:

$$H = H_o (1 - 0.8 e^{-0.6 d/H_o}) \quad H_o \geq 0.3$$

Where H is the wave formed on the reef, H_o is the wave near the breakpoint and d is the mean water depth at the reef crest. The range of water depths for which the formula is d/H_o = 0 to about 5.

The secondary wave tends to approach the beach from the south and south west due to the shape of the reef at the Rarotongan Hotel. This trend may in part be the cause for the shape of the shoreline at this location. The discharge of sand by the small creek at its former location may have also influenced the location of the sand projection. The major impact of these waves is to cause a west to east current from the pumping action of the waves over the reef. At 09010 hours on 1 June 1984 a 15 second swell was observed on the reef. The breakers were estimated to be 3.66m in height. The lagoon current was estimated to be between one-third knot to one knot just south of the hotel. The depth of the water at the groyne was observed to reach the beach. Two smaller waves appeared to form on the times when depth of water at the reef was on the order of one meter these secondary waves could be .7m in height. They could transport up to 56 cubic meters of sand eastward in one day depending upon the angle of attack. They would be expected to sort the beach sand and transport the finer fraction to the fore beach.

A weather front passed on 8 May 1984 that produced a low of 997mb at the airport. The wind was from the south at 50k with gusts to 70k. The seas would be predicted to be 4.9m at 9 seconds. The change in barometric pressure associated with a 50k wind could cause a .34m rise in sea level at the reef and the wave set up could increase sea level another 0.47. At high tide the total water depth at the reef would be on the order of 1.31m. The wave to develop on the reef could be as much as 1.07m. The sand ripple observed following the storm tended to confirm in height. Using the method developed by Davis (1976) the wave in would appear that a .08m rise in water level and a 1.1 meter wave over the reef can be associated with a onshore 50k wind at this location.

Storm Water Levels

Major storms that produce a significant rise in the sea level and generate waves that reach the reef will cause much level and generate waves that reach the reef will cause much larger waves to attack the beach. The depth of water at the reef is a major controlling factor in determining the size of wave to reach the beach. Wave set up as shown previous can increase the depth of water significantly. The water in the wave breaking at the shore will have energy to produce run-up on a beach or

breakwater. Overtopping can result followed by flooding and erosion if the structure at the shore is lower than the resulting water level. An analysis of the frequency for different rises in water level height of wave over the reef, and the highest wetted at the reef and a beach or seawall slope of .1237 was made based on information derived from the 1967 hurricane. The calculated values were:

Recurrence (Years)	Rise in W.L (m)	Reef Wave (M)	Wetted Height (m)
1	.34	.28	1.00
2	.61	.50	1.70
3	.78	.63	2.11
4	.89	.72	2.40
5	.98	.80	2.62
6	1.05	.85	2.81
7	1.11	.90	2.96
8	1.17	.95	3.10
9	1.21	.99	3.22
10	1.25	1.02	3.32
11	1.29	1.05	3.42
12	1.33	1.08	3.51
15	1.41	1.15	3.77
20	1.53	1.24	4.02
30	1.69	1.37	4.43
50	1.89	1.54	4.95

The elevation of the top of the beach berm and the ground level upon which the hotel is located is between 2.4 and 2.7m (msl). The water heights indicated above are referenced to msl; hence, it is evident that some local flooding can be expected to occur every four or five years due to local storm action. Serious flooding would be expected to occur every 15 to 20 years due to the secondary reef wave.

Now consider the wind wave over the reef during the storm and assume 635m fetch 1 meter plus storm for depth and a recurrence period wind speed. The wind wave generated over the reef would add to the secondary wave that resulted from the breaking of ocean waves at the reef when they were in phase. The critical point would be at the shoreline. Probably every 36 waves or so they would be in phase at the shoreline or 20 or so such condition might occur during a 20 year cyclone. If the combined wave did not break before the shore it would overtop about 1.5m in 30 years. This amount of water would result in serious local flooding. The 50 year condition may overtop by 1.9m or more. Based upon these data a 30 to 40 year seawall design period may be indicated. The top of the seawall should not exceed 2.6m (msl), the present height at the shoreline.

Design Wave

As the Rarotongan Hotel features its ocean and ready access to the beach, construction of a high protective seawall would be counter productive. As a compromise it is suggested that a seawall be designed approximately level with the present shoreline, and that it be backed with some catchment area to accommodate a modest amount of overtopping. The size could be some in excess of that indicated by the storm that would just overtop. Say a 40 year recurrence period is employed for the storm. This storm could result in serious flooding; however, the seawall would be expected to survive. The following design wave was suggested based upon the above considerations.

It is recommended that the design wave to be employed for selection of the seawall is that that would be produced by a tropical cyclone having a 40 year recurrence period. This cyclone would have a maximum wind speed of 86.2k, and the deep water wave that could result would have a significant wave height on the order of 7.2m and a period approximately 10.1 sec. The wave set could be 0.74m. The barometric tide would be on the order of 1.1m giving a rise in water level on the reef flat would be 0.91m in height, have a period of 3.1 sec, a breaker depth of 1m and a breaker height of 1.5m and a period similar to the generating wave. The combined wave height could be as much as 2.4m. The present top of the shoreline is about 2.6m (msl), so as much as 0.7m of overtopping would occur. When the waves got into phase as they approached the shoreline they would break due to water depth; however, the overtopping would increase and a larger volume of water would be introduced behind the seawall. It would be in excess of the return capacity of the facility and flooding would occur. A storm having a five year return period would not be expected to produce overtopping.

Shoreline Changes

Several land surveys have been made in the vicinity of the Rarotonga Hotel that show either the shoreline, low or high water level. In addition several sets of beach and near shore profiles have been made both before the construction and following of the hotel. Some aerial photographs have also been taken of this portion of the reef and shoreline. All of these documents were not available to review at the drafting of this report. A set of profiles made by the Public Works in 1980 and 1981, a current survey, and one made just prior to construction were employed to evaluate the changes that have taken place in the shoreline in recent times.

The shoreline has been divided into sections, west to east for the purpose of discussion. The following sand transport conditions appear from the available information.

Section 1 lies to the west of the Rarotongan Hotel beach as shown in Figure 1. It has during the past three years lost sand at an estimated rate of 255cm per year (cm = cubic meters). Some 73 percent may have transported westward by trade winds waves and the remainder appears to have been washed out onto the near shore by secondary reef waves where strong reef currents carried the sand eastward. There is no evidence of shoaling to the west.

Section II, the main for the hotel, appears to have gained sand at a rate of 85cm per year. It is sheltered from the trade wind waves by the shape of the shoreline. Some loss of sand has occurred in the near shore area. Again the alongshore reef current may have carried this sand eastward. Some 73cm of sand are transported annually to this section by trade wind waves from section III.

Section III the short section of the beach between the two groynes has experienced a net gain (combined beach and near shore) of sand at the rate of approximately 19cm per year, the rate of accretion onto the beach was 67cm per year and the rate of loss from the north shore was 48cm per year. Some 127cm of sand was added to this section from section IV and 73cm passed onto section II. Apparently the sand exchange includes some 13cm of sand pass eastward into this section in the near shore area and 306cm may have pass out to the east.

Section IV is the section of shore east of the groynes that has experienced so much erosion since construction of the hotel. The shoreline appears to have eroded some 12 meters in 6 years or at an average rate of 2m per year. During the past three years this rate has slowed to 0.67m per year. Sand appears to be transported along the shore at a rate of 127cm per year in this section; however, as sand may be added at a rate of 144cm per year from section V to the east, the section may accumulate sand in the near shore area at a rate of 17cm or more per year. The back beach appears to contribute some sand to the near shore and this movement of sand the erosion of sand causes the erosion of the shoreline.

Section V is the beach area near the small creek adjacent to the east hotel boundary. The small delta has eroded at a rate of 72cm per year. There does not appear to be much sand deposited from the creek. The long beach to the east of section V should contribute sand at a rate of 72cm per year to section V to make up the calculated 144cm per year that is transported to the west.

At the production rate of 1.5kg per square meter per year over 2/3 of the nearby reef area, some 204cm of new sand should be added to the system each year (see page 33 1981 CCOP/SOPAC Training Workshop, Suva Fiji for the rate of biological sand production at 21 deg. Lat). This sand plus the 306cm of sand transported by the reef current from the west should add to 510

cm of sand that is mined, deposited upon the reef flats, transported to the beach area to the east, or lost to the sea return each year.

It has been reported that a significant quantity of sand mined from the near shore area for fill in the hotel area during the construction of the hotel. Much of the above 510cm of sand deficiency created during construction.

Mining of Sand

Mining of beach sand for road and other construction needs has existed for many years in Rarotonga. A significant amount of sand mining occurred between 1960 and 1970 for road fill. Three yard truck loads were the common size during former. More recent a 5 yard load is the usual size. Sand is delivered to job site for \$50 (NZ) in 4cm truck loads. The beach area at Rutaki day for an average of 69 days per year for about 10 years or some about one nautical mile of shoreline was involved. This amount of sand would be as much or more than that now present in the beach and near shore are for the same region.

As equilibrium exists between the beach and near shore sand, removal of either will result in a shift of sand from one to the other. The wave energy dissipation by the action of the wave upon the sand will now be less efficient at the same point and there is a tendency for the shoreline to erode during the natural process of restoring the original equilibrium condition. The removal of such a large fraction of the available beach sand as above can be expected to result in significant shoreline changes. Some of these changes will not be observed until the larger waves are present as will occur during the major storms. In order to resist such changes, it will be necessary to restore at least part of the sand removed and/or construct coastal protection facilities if the shoreline is to be stabilized. In the case of the hotel beach are, it would appear that both measures will be required.

ALTERNATIVE SHORE PROTECTION ACTION

The more serious beach process will respect to the Rarotongan Hotel area is the receding shoreline at section IV. Two factors appear to contribute to this shoreline erosion. One is removal of sand from the beach but the run-up from the larger secondary reef waves and its subsequent deposition in the near shore area. The second factor is the east to west sand transport by the trade wind generated wave and a less frequent west to east transport by the west and southwest winds.

The presence of a storm bar on the reef flat restricts the

current to a rather narrow channel near to the beach at section I. Also the current becomes stronger around the seaward end of the groynes and it always sets in a west to east direction, so once sand enters this zone it is carried away.

To correct this condition it appears necessary to reduce the strength of the alongshore reef current near to beach and supply some quantity of sand to beach section IV. It may also be necessary to cause some wave diffraction to occur out on the reef flat and reduce the transport of water to beach section I and II. A channel could be cut into the storm bar and so reduce the current velocity in the near shore channel. A low mound could be constructed from the material cut from the bar channel, and it could be located to cause the secondary reef waves to diffract eastward and not impact the beach at section I and II. An alternative to the construction of the mound would be to close the 55m wide 1m deep near shore channel completely. This could result in an increase in beach erosion further along the coast to the west as the sand supply for the area would be reduced.

The problem of the transport of sand away from section IV at a rate greater than its transport to the area can be approached in several ways. One method would be to construct a seawall. Another would be to increase the efficiency of the groyne in section III. Another method would be to construct a detached breakwater, and a fourth would be to add sufficient sand to the area to survive several storm conditions.

Beach rock was reported to have been found in test excavation made before construction of the hotel. The seaward part of the hotel was reported to be located over the beach rock hence, the shoreline was at one time back as far as the present location of the hotel, and it may be expected to return to that location again if unstabilized.

Consideration of the safety of the hotel structure, the rather high possibility of a significant tropical cyclone, and the close proximity of the hotel to the shoreline would indicate that a seawall of some type should be included in the protection scheme. There is no question that if nothing is done to retard the erosion of the shoreline that the sea will undercut part of the hotel structure in a relatively short time. As there is no solid rock formation to protect the sand projection upon which the hotel is constructed it is advisable to build one.

Groynes

One of the problems with use of a conventional type groyne at the Rarotongan hotel beach is that it will cause the reef current water to accelerate around the seaward end and the resulting higher velocity of water will scour the sand to increase the channel section during times of strong reef currents. This area at the end of the groyne will be a hazard to children that might

venture to close to the end of the groyne. They can be caught up in the current and swept deep into deep water before they are aware that they were in trouble. An alternative to such a structure would be a low level mound of small size rock that would cause the waves to diffract around the mound and also reduce the sand transport past the area. The gentle sloping sides of the mound prevent scour. Such a mound could form the footing for a 1:5 seawall located at the apex of the sandy shoreline in section III. Another problem with sand tight groynes is that it can be slowing the sand feed rate to the beach. The groyne system suggested by Raudkiwi (1984) would trap sand at the point however, it would have above problems.

Detached Breakwater

A “U” shaped breakwater placed seaward to the sand point at section III would provide some protection to the area. A sand bar or tomobolo would form behind the structure by sand transported along the shoreline, and sand should accumulate on each side of the tombolo due to the shape of the reef.

Such a structure might be 2.8m high and 90m long. It would require 650cm filter rock for the core and base and 950cm of armor rock. The base would be 12m wide, 0.3m thick, the sides would be on a 1.5:1 slope and the armor would be 1.61m on the seaward side and 0.6 on the landside. The seaward side should have two layers of armor, and at the breaker level the rock should be 10 ton each in weight. The large rock would be almost as large as the 1.61m thickness so they would require individual placement in order to maintain the two layers. At \$32 per cm the 645nm of filter would cost \$20, 640. The 950cm of armor would cost on the order of \$30, 140 (NZ). Such a structure would not be attractive with respect to the hotel beach.

Seawall for Beach Section IV

A seawall could be located along section IV where the shoreline is receding. Such a structure would perform several functions. The more important is to minimize wave reflection and transform wave energy to hat. A second function is to reduce flooding on shore and provide a return route for overtopping water. Another function is this case is to prevent beach erosion due to the trade wind generate waves.

The Hudson formula for rubble structure was employed to select the armor store weight, W.

$$W = w H^3 / K (s-1) \cot a \quad 4$$

Where w is the specific weight of the rock, H is the design wave height, K is 4 for non-breaking waves and two layers of rough

stone, s is the specific gravity of stone related to sea water, and a is the angle of slope measured from horizontal. Using s of 2.21 a of 11.3 degrees, H of 1.53m the weight, W of the armor cm of filter and 4300 per cm of filter delivered, the material cost would be on the order of (NZ) \$83, 448.

Reno Blanket

A Reno blanket type of shore protected could be substituted for the armor rock above. It would be advisable to utilize the above filter layer beneath the covering. The 6 x 2 x .23cm wire net would cost around (NZ) \$233.25 each delivered to Rarotonga. The rock was estimated to costs \$100 per 5cm delivered, and some costs \$66, 100 and with the filter the total materials cost would be about (NZ) \$106, 548.

Point Structure and Diffraction Mound

With both the seawall and Reno Blanket systems, additional protection will be required at section III beach, the point. In fact it may be adequate to provide protection at the point and with the addition of a sand reserve the need for further protection along section IV may prove unnecessary; however, based section of beach will require protection.

The point structure would be identical to the seawall except that it would use 0.5 ton stone and be constructed in the form of a truncated cone. With the seawall as an extension in would extend over 180 degrees, and without the sea wall it would have short extensions to protect the ends? The armor layer would be 1.4m in thickness, and the filter would be 0.3m thick. At \$10 per ton 1840 tons would cost (NZ) \$18,400 and the filter rock at \$32 per cm would cost (NZ) \$30, 400. Materials costs would be about (NZ) \$48, 800.

The diffraction mound would be located at the base of the point structure on the seaward side. It would be a one meter high, 60 meter diameter half circle cone of 7.5 centimeter rock. It would contain approximately 100cm of material and at a cost of \$32 per cm the material would cost around (NZ) \$3, 200.

Sand Reserve

Some 1,500cm of 1mm or larger sand should be distributed along beach section IV. At a costs of \$15, 000.

Diversion Channel and Diffraction Mound

A 60m wide 1m deep “U” shaped channel should be cut along a bearing of approximately 130 degrees true about one-half way across the storm bar located to the right of the hotel facing south. The end of this bar is off beach section I. the spoils from this channel could be used to form a low cone diffraction mound just southwest of the channel cut in the bar. Part of the spoils could also be employed to reduce the size of the channel near shore off the end of the bar. The mound should be as high as the present bar at its top and it should have a radius of at least 50cm it should have a gentle slope.

CONCLUSIONS AND RECOMENDATIONS

The following conclusions are tentative and are based upon the above report.

1. The diversion channel should be cut into the storm bar immediately to relieve some of the near shore hydraulic gradient and reduce the velocity of the near shore reef current.
2. The point structure and sand reserve protection measures should be implemented immediately.
3. The 40 tropical cyclone is the appropriate design storm to be employed for beach protection at the Rarotongan Hotel Beach site.
4. The near shore reef current is a major factor causing the erosion of the shoreline at the hotel.
5. The trade wind generated wave is a significant factor in the east to west transport of sand along the hotel beach.
6. The shoreline is being eroded along beach section IV at a rate less then 2m per year.

References

Smith, P. Hauoli, 1984 Personal Interview 26/5/84

Coulter, J.D and J.W.D Hessel, 1980 “The Frequency of High Intensity Rainfall in New Zealand, Part II, Point Estimates”. Ministry of Transport, New Zealand Meteorological Service, Misc. Pub 162 ISSN 0110-6937.

Map of Rarotonga, 1st Edition 1970 Published by Lands & Survey Department of Government of Cook Islands scale 1:15840.

Kerr, I. S., 1976 “Tropical Storms and Hurricanes in the Southwest Pacific Nov. 1939 to April 1969”. New Zealand Metrological Service Misc. Pub 148.

Revell, C. G., 1981 "Tropical Cyclones in the Southwest Pacific. Nov 1969 to April 1979" New Zealand Meteorological Service Misc. Pub 170.

Intertect, 1982 "Improvement of low-cost housing in the Cook Islands to withstand tropical storms". Study Prepared for USAID Contract No PDC-0224-C-00-1113-00

U.S Corp., 1977 "Shore Protection Manual, Vol I and II" US Army Coastal Engineering Research Enter.

Seelig, W. N., 1983 "Laboratory Study of Reef-Lagoon System Hydraulics". Jour. Of Waterways, Port, Coastal and Ocean Engineering, Vol 109, No 4 November 1983

Roberts, Harry H., 1980 "Physical Processed and Sediment Flux through Reef-Lagoon Systems" Proceedings of the 17th International Coastal Engineering Conference ASCE/Sydney, Australia March 23-28, 1980

Davis, Richard A., 1976 "Beach and near shore Sedimentation" Society of Economic Paleontologists and Mineralogist spec. pub no 24 October 1976 Tulsa, Oklahoma, USA

Myers, Holm and McAllister, 1969 "Handbook of Ocean and Underwater Engineering", McGraw Hill

Reid, S.J and A.C. Penny, 1982 "Upper-level wind frequencies and mean speeds for New Zealand and Pacific Island Stations. New Zealand and Pacific Islands Stations. New Zealand Meteorological Services Misc. Pub. 174

Radukivi, A. J., 1984 "Rarotongan Hotel Beach Reinstatement" Report Prepared for JASMAD Group Ltd. Auckland, New Zealand 29 March 1984

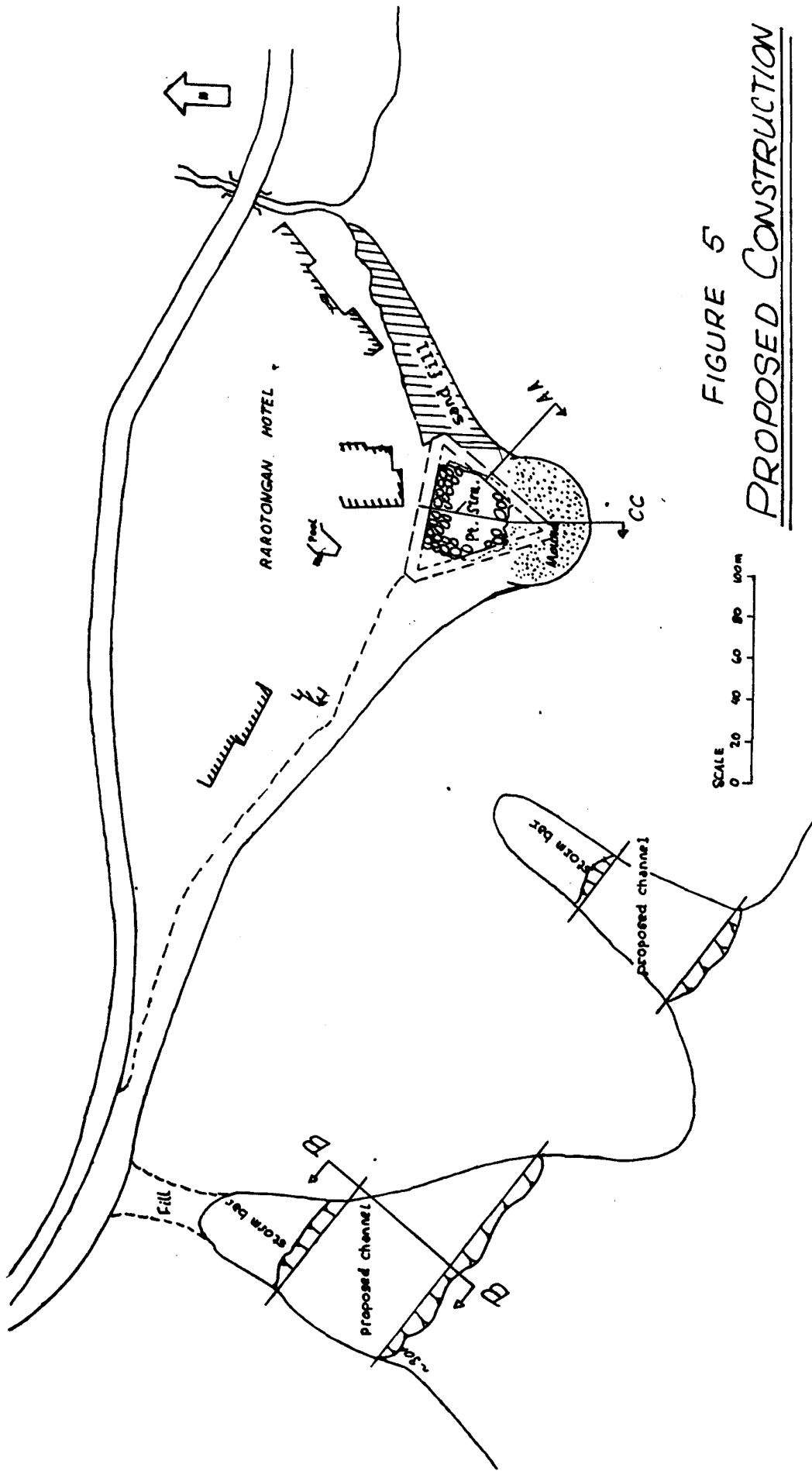
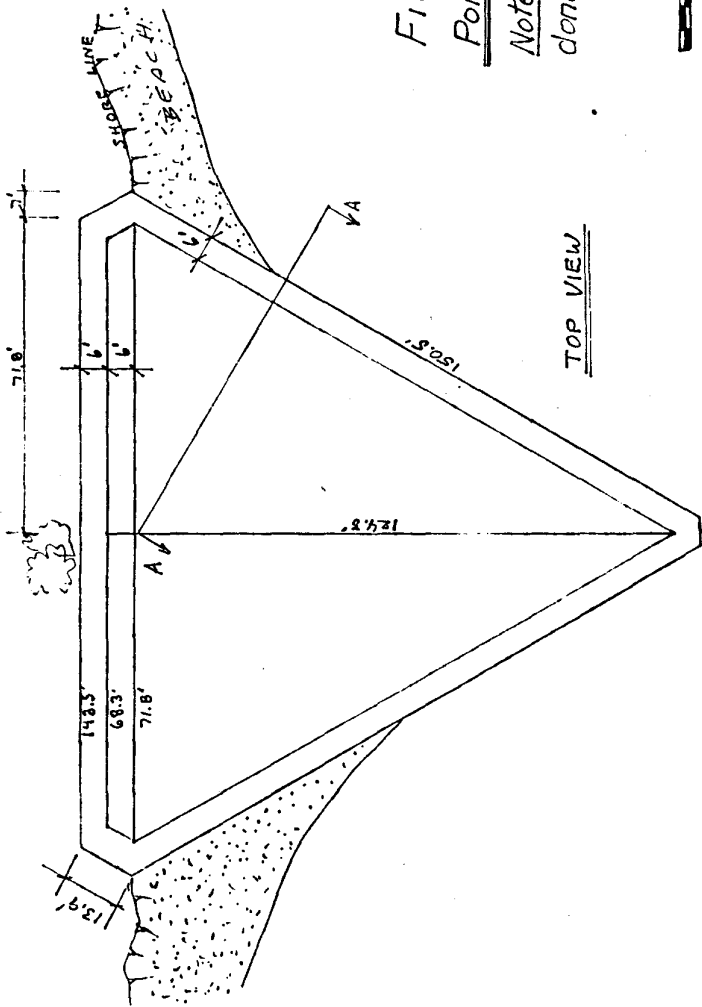
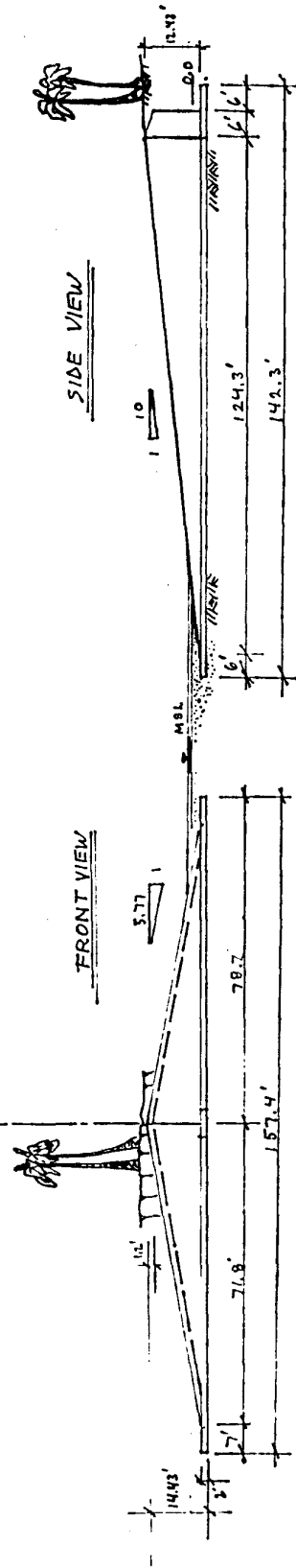
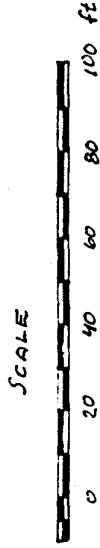

FIGURE 5
PROPOSED CONSTRUCTION



TOP VIEW

FIGURE 6
Point Structure
Note: No foundation work
done.



SIDE VIEW

FRONT VIEW

SECTION C-C

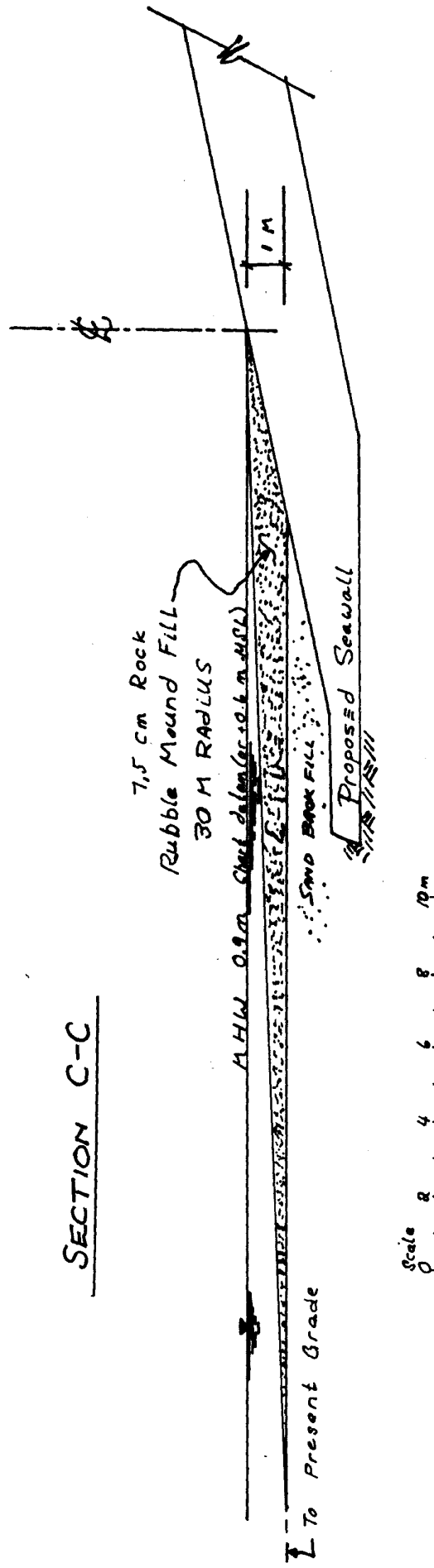
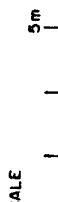
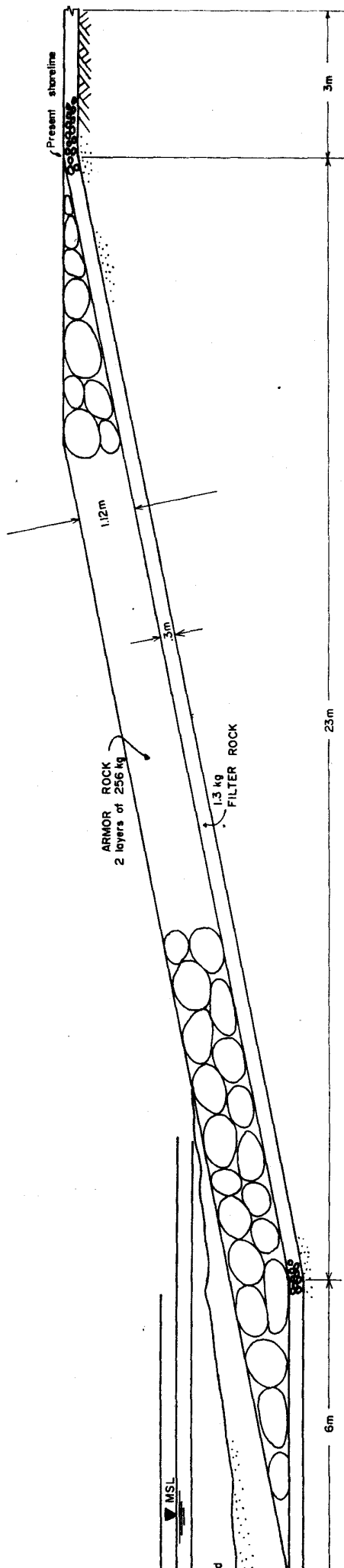
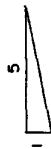

FIGURE 8
DIFFRACTION MOUND PROFILE

Length of seawall - 160m

USE ANGULAR ROCK
s.g. = 2.21



PROPOSED RUBBLE MOUND SEAWALL FOR
BEACH SECTION IV RAROTONGAN HOTEL

FIG. 4

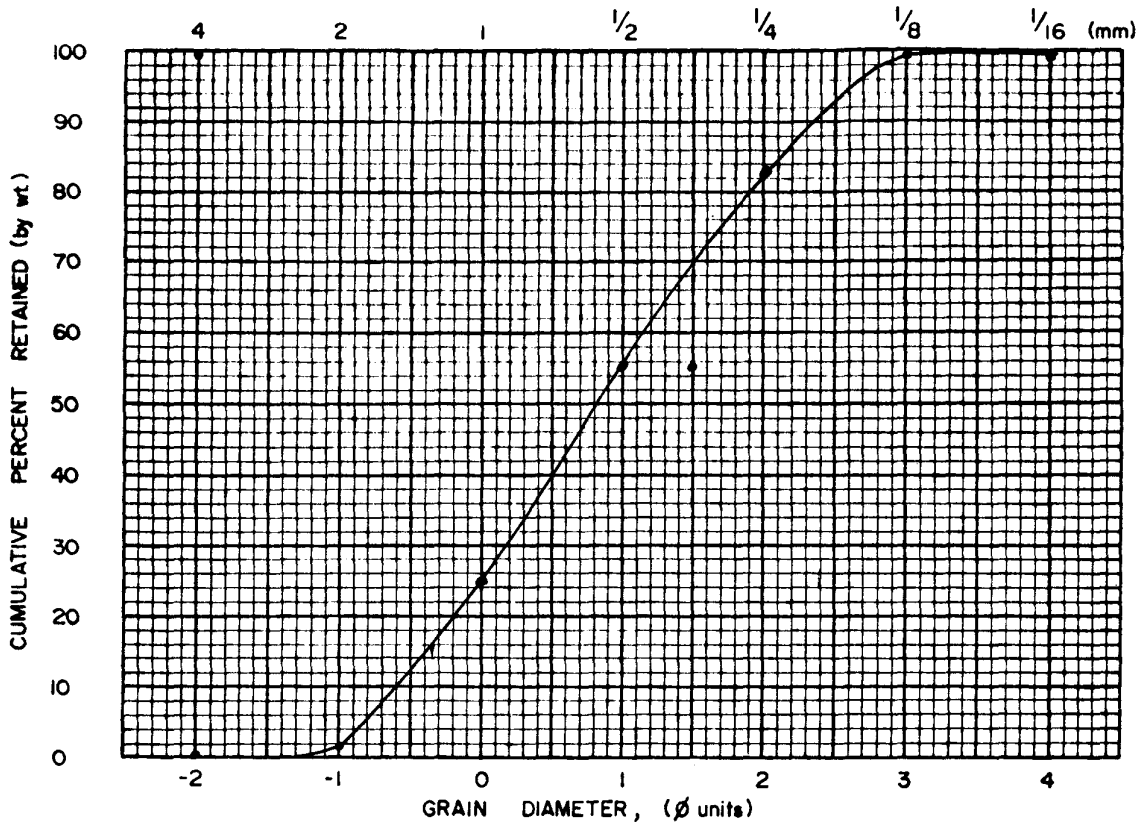

SAMPLE NO 1 LOCATION RAROTONGAN Hotel Beach

DESCRIPTION Collected mid-tide level EAST CREEK 10/6/84

DESCRIPTIVE PARAMETERS:

Phi median diam, $Md\phi = \phi_{50}$ 0.81

Phi mean diam, $M\phi = \frac{1}{2}(\phi_{16} + \phi_{84})$.97

Sorting, $\sigma\phi = \frac{1}{2}(\phi_{84} - \phi_{16})$ 1.20

Skewness, $\alpha\phi = \frac{M\phi - Md\phi}{\sigma\phi}$ 0.05

COMMENTS: _____

Calculated by Ralf Carter
 Date 24/8/84

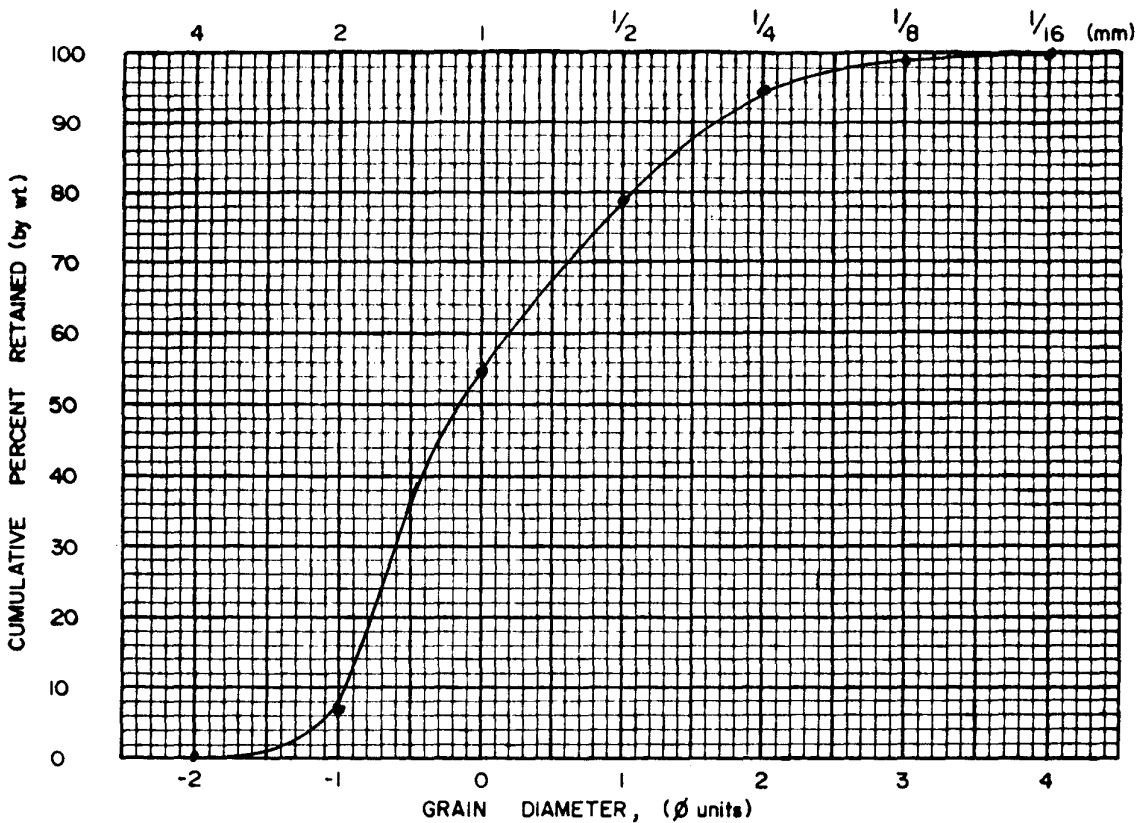

SAMPLE NO 2 LOCATION Rarotongan Hotel Beach
 DESCRIPTION Section IV mid-tide level 10/6/84

DESCRIPTIVE PARAMETERS:

Phi median diam, $Md\phi = \phi_{50}$ -0.16
 Phi mean diam, $M\phi = \frac{1}{2}(\phi_{16} + \phi_{84})$ 0.23
 Sorting, $\sigma\phi = \frac{1}{2}(\phi_{84} - \phi_{16})$ 1.07
 Skewness, $\alpha\phi = \frac{M\phi - Md\phi}{\sigma\phi}$ 0.36

COMMENTS: _____

Calculated by Ralf Carter
 Date 24/8/84

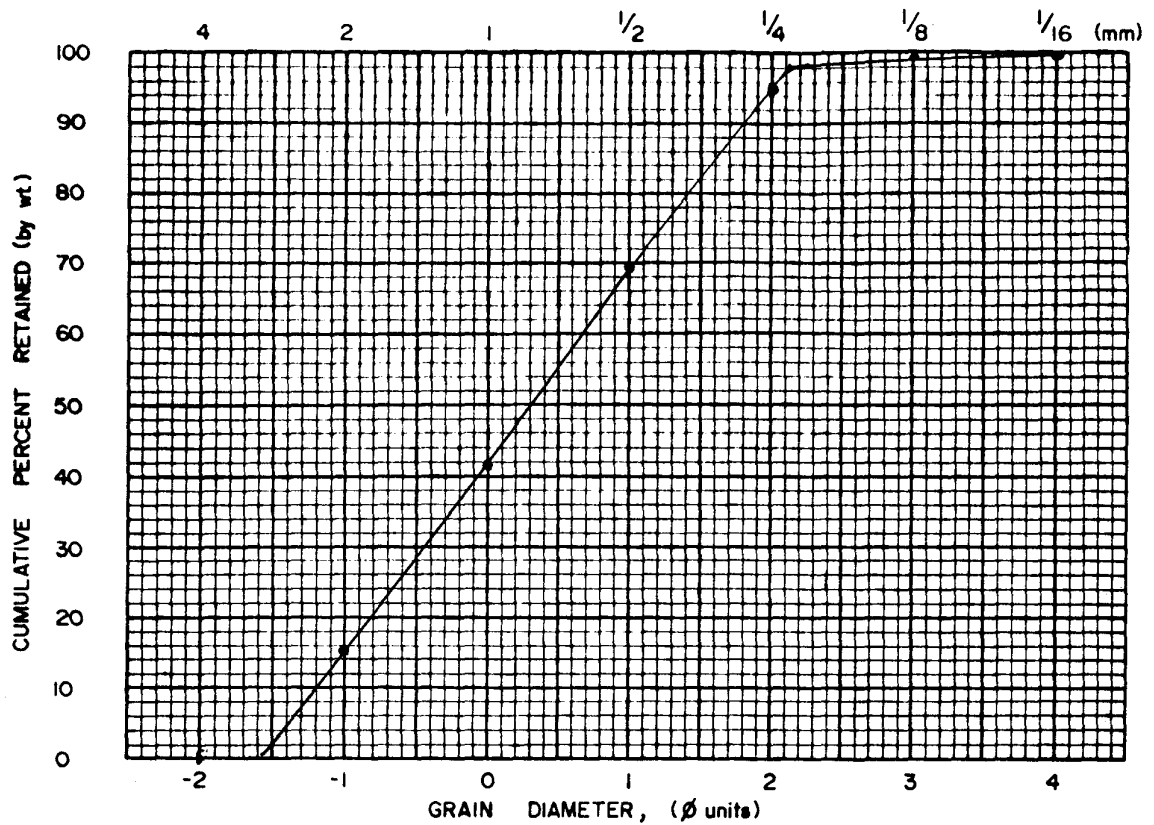

SAMPLE NO 3 LOCATION Rantonga Hotel Beach
 DESCRIPTION Beach Sand from 17th at Section III 10/6/04

DESCRIPTIVE PARAMETERS:

Phi median diam, $Md\phi = \phi_{50}$ 0.30
 Phi mean diam, $M\phi = \frac{1}{2}(\phi_{16} + \phi_{84})$ 0.30
 Sorting, $\sigma\phi = \frac{1}{2}(\phi_{84} - \phi_{16})$ 1.27
 Skewness, $\alpha\phi = \frac{M\phi - Md\phi}{\sigma\phi}$ 0.00

COMMENTS: _____

Calculated by *P. J. Carter*
 Date 24/0/04

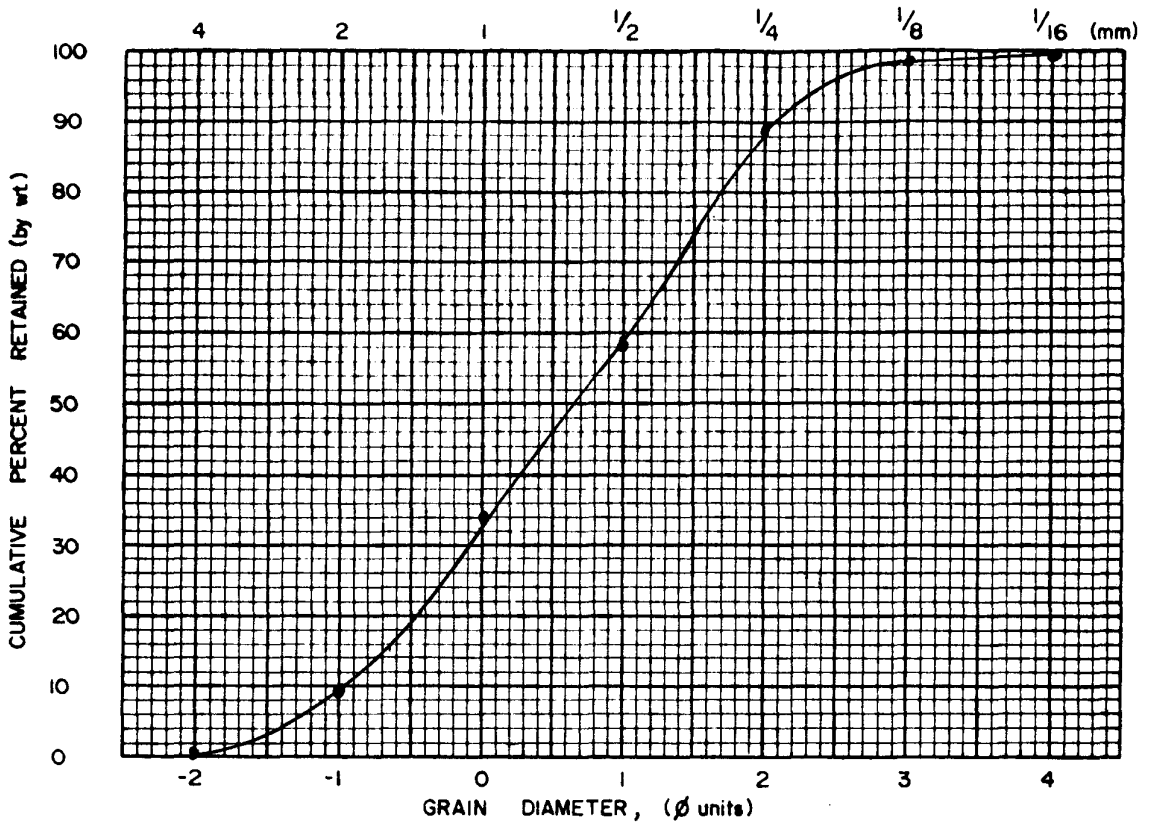

SAMPLE NO 4 LOCATION Barotongan Hotel
 DESCRIPTION Beach Section II @ MTL 10/6/84

DESCRIPTIVE PARAMETERS:

Phi median diam, $Md\phi = \phi_{50}$ 0.65
 Phi mean diam, $M\phi = \frac{1}{2}(\phi_{16} + \phi_{84})$ 0.59
 Sorting, $\sigma\phi = \frac{1}{2}(\phi_{84} - \phi_{16})$ 1.24
 Skewness, $\alpha\phi = \frac{M\phi - Md\phi}{\sigma\phi}$ -0.05

COMMENTS: _____

Calculated by Ralf Cortes
 Date 24/8/84

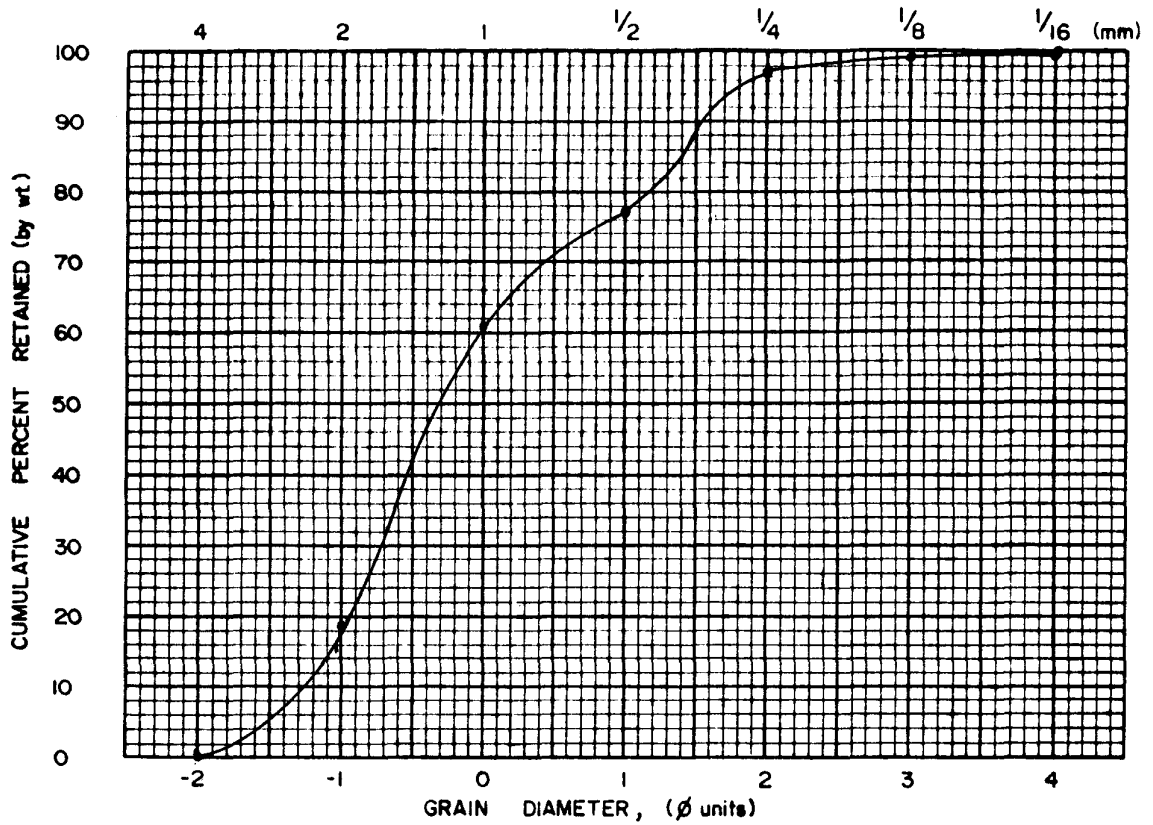

SAMPLE NO 5 LOCATION Rawtongan Hotel
 DESCRIPTION Beach Section I @ MTL 10/6/04

DESCRIPTIVE PARAMETERS:

Phi median diam, $Md\phi = \phi_{50}$ -0.32
 Phi mean diam, $M\phi = \frac{1}{2}(\phi_{16} + \phi_{84})$ 0.17
 Sorting, $\sigma\phi = \frac{1}{2}(\phi_{84} - \phi_{16})$ 1.20
 Skewness, $\alpha\phi = \frac{M\phi - Md\phi}{\sigma\phi}$ 0.41

COMMENTS: _____

Calculated by Ralf Carter
 Date 24/8/04

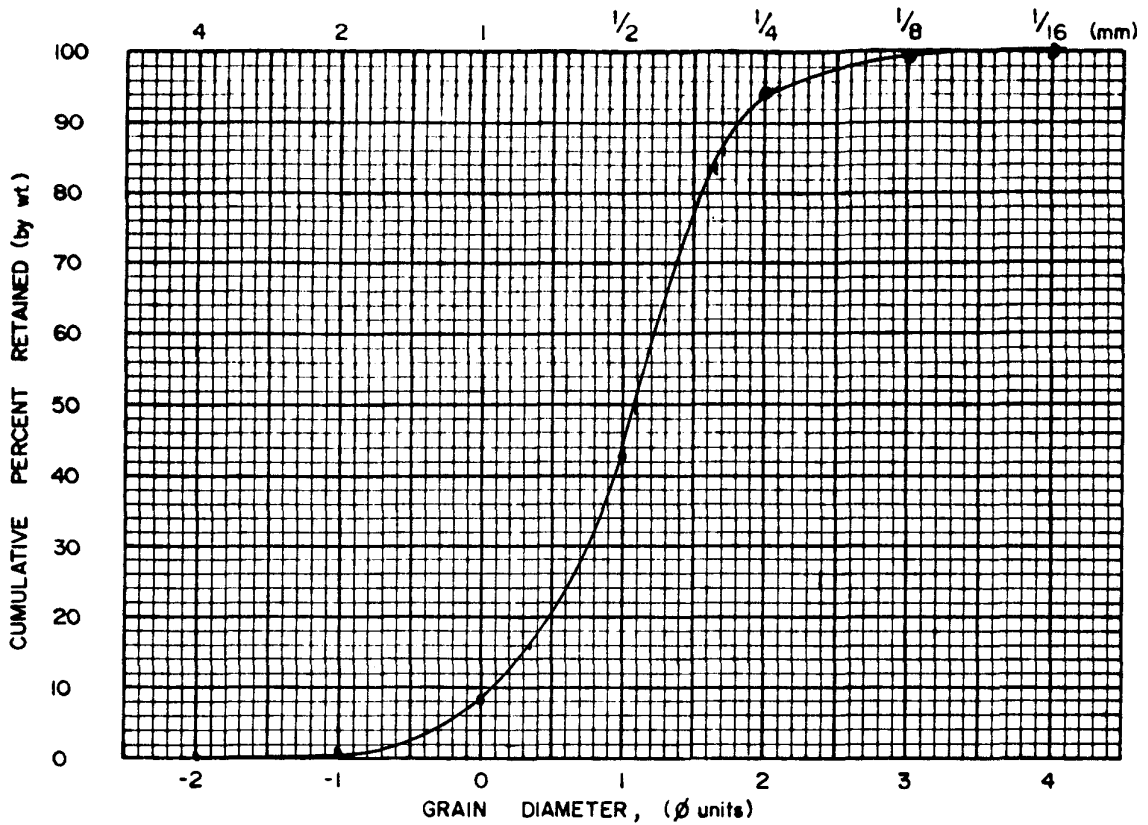

SAMPLE NO 6 LOCATION Rarotongan Hotel
 DESCRIPTION Sand from stream bed @ Section II 14/6/84

DESCRIPTIVE PARAMETERS:

Phi median diam, $Md\phi = \phi_{50}$ 1.08
 Phi mean diam, $M\phi = \frac{1}{2}(\phi_{16} + \phi_{84})$ 0.99
 Sorting, $\sigma\phi = \frac{1}{2}(\phi_{84} - \phi_{16})$ 0.65
 Skewness, $\alpha\phi = \frac{M\phi - Md\phi}{\sigma\phi}$ -0.14

COMMENTS: _____

Calculated by Ralf Carter
 Date 24/8/84

APPENDIX II
 Profile Tabulation - Rarotongan
 Hotel Site
 Survey: May-June 1984

STATION	R.L.	REMARKS	STATION	R.L.	REMARKS
PV	0.40		A 4	0.90	
R. 4.5m	0.89		R. 1.8m	0.95	
R. 7m	1.14		R. 9m	0.96	
R. 11m	1.93	Top of bank	R. 10m	1.11	
R. 14.6m	2.11		R. 15m	2.15	Top of bank
L. 2.2m	0.59		R. 16m	2.41	
L. 4.5m	0.20	Beach toe	L. 6m	0.25	
L. 9.6m	0.12		L. 12m	0.15	
L. 19m	0.06		L. 19m	0.04	
A 1	0.37		A 5	0.37	
R. 3m	0.49		R. 2m	0.61	
R. 7m	0.72		R. 5m	1.00	
R. 12m	0.96		R. 7.5m	1.57	
R. 17m	1.36		R. 10.5m	2.22	Top of bank
R. 20.7m	2.24		R. 12.5m	2.40	
L. 4m	0.29		R. 17.5m	2.32	
L. 9m	0.23		L. 1.4m	0.24	Beach toe
L. 14m	0.14		L. 8m	0.04	
L. 19m	0.10		L. 17m	0.02	
A 2	R. 6.4m 0.44		A 6	0.50	
R. 16.4m	0.54		R. 1.5m	0.72	
R. 21.4m	0.60		R. 4.4m	1.09	
L. 5.6m	0.34		R. 6.6m	1.50	
L. 28.4m	0.03		R. 8m	2.04	
A 3	0.95		R. 10.6m	2.68	Top of bank
R. 7m	0.43		R. 12.8m	2.71	
R. 12m	0.84		L. 2.4m	0.18	Beach toe
R. 16m	1.23		L. 12m	0.02	
R. 21m	2.36	Top of bank	L. 19m	-0.02	
R. 24m	2.47		A 7	0.79	
R. 29m	2.45		R. 2.2m	1.09	
L. 5m	0.29		R. 4.5m	1.62	
L. 12.7m	0.19		R. 7m	2.15	
L. 19m	0.09		R. 8m	2.75	Top of bank
			R. 12m	2.94	

Legend. Profiles labelled as per Fig. 2
 R.L. denotes reduced level (1951)
 - signs indicate below M.S.L.
 R. denotes north of traverse
 L. denotes south of traverse

APPENDIX II
 Profile Tabulation - Rarotongan
 Hotel Site
 Survey: May-June 1984

STATION	R.L.	REMARKS	STATION	R.L.	REMARKS	STATION	R.L.	REMARKS
A 8	1.19	-	B 3	2.66		C 1	-	No R.L. taken
R. 2.8m	1.75	-	L. 5.9m	2.87	-	L. 6.4m	1.38	No ground
R. 5m	2.11	-	L. 7m	2.15	-	L. 12.3m	0.85	
R. 6.5m	2.69	Top of bank	L. 15m	1.86	Top of bank	L. 18.1m	0.17	
R. 12.5m	2.65		L. 17m	0.86		L. 26.8m	-0.09	
L. 4m	0.52		L. 21m	0.40	Beach toe	L. 36m	-0.24	
L. 7.6m	-0.08		L. 24.6m	-0.06	(Nu ariyne)	C 2	2.26	
L. 30m	-0.46		L. 33m	-0.38	↓	R. 2.5m	2.52	Top of bank
A 9	1.65	-	L. 42m	-0.38		R. 5.4m	2.38	
R. 1.5m	1.95	-	L. 51m	-0.38		L. 5.5m	1.52	
R. 3.7m	2.85	Top of bank	B 4	2.55		L. 10.4m	0.92	
R. 6.2m	2.77		L. 4.8m	2.89	Top of bank	L. 16m	0.12	Beach toe
L. 6.8m	0.52		L. 6.6m	2.15		L. 28m	-0.64	
L. 13m	-0.08		L. 11m	1.60		L. 35m	-0.78	
L. 19.6m	-0.42		L. 14.7m	0.83		C 3	2.52	
L. 30m	-0.32		L. 18m	0.12	Beach toe	R. 3.7m	2.32	Top of bank
A 10	2.78	-	L. 29.5m	-0.40		R. 7.2m	2.47	
R. 5.8m	2.64	-	L. 40m	-0.49		L. 5.5m	1.58	
L. 1.3m	2.06	-	L. 48	-0.49		L. 7.4m	0.97	
L. 8.2m	0.64		B 5	2.64		L. 15m	0.13	Beach toe
L. 12.2m	0.08	Beach toe	L. 7.7m	2.24		L. 27m	-0.47	
L. 18.2m	-0.28		L. 12.5m	0.83		L. 37m	-0.99	
L. 30m	-0.53		L. 15m	0.26	Top of bank	C 4	2.47	
B 1	2.77	-	L. 22m	-0.54	Beach toe	R. 3m	2.55	
L. 6.7m	2.87	Top of bank	L. 29m	-0.38		R. 5.8m	2.46	
L. 10m	1.42		L. 45m	-0.49		L. 4.7m	1.78	
L. 15.9m	0.80		B. 6	2.81	-	L. 9.2m	1.02	
L. 18.9m	0.09		L. 3.9m	2.68	Top of bank	L. 15m	0.13	Beach toe
L. 29m	-0.23		L. 7.3m	1.65		L. 26m	-0.45	
L. 37m	-0.50		L. 12.5m	0.62		L. 39m	-0.62	
L. 46m	-0.43		L. 15.8m	0.14	Beach toe	C 5	2.50	
B 2	2.82	-	L. 24.8m	-0.30		R. 3m	2.50	
L. 7.5m	2.96	Top of bank	L. 35.8m	-0.43		L. 3.6m	1.83	
L. 8.8m	1.78		L. 44m	-0.58		L. 10.1m	0.85	
L. 15.9m	1.15					L. 16.5m	0.08	Beach toe
L. 20m	0.32					L. 28.5	-0.45	
L. 30m	-0.19					L. 39.5	-0.55	
L. 38.7m	-0.24							
L. 50m	-0.52							

Legend. Profiles labelled as per Fig. 2
 R.L. denotes reduced level (1951)
 - signs indicate below M.S.L.
 R. denotes north of traverse
 L. denotes south of traverse

APPENDIX II
 Profile Tabulation - Rarotongan
 Hotel Site
 Survey: May-June 1984

STATION	R.L.	REMARKS	STATION	R.L.	REMARKS	STATION	R.L.	REMARKS
C 6	2.71		D 4	2.76		E 4	3.12	
N. 3.6m	2.40		L. 6.5m	2.76	Top of bank	L. 2m	2.92	Top of bank
L. 9.4m	2.08		L. 19.2m	0.93		L. 10m	1.37	
L. 11.5m	1.00		L. 27.3m	0.04	Beach toe	L. 18m	0.29	Beach toe
L. 17.4m	0.19	Beach toe	L. 41m	-0.71		L. 24m	-0.53	
L. 37.4m	-0.44		D 5	2.63		L. 32m	-0.86	
L. 42m	-0.98		L. 5.8m	2.78	Top of bank	L. 39m	-0.98	
C 7	2.59		L. 13.2m	1.60				
L. 5.7m	2.28		L. 23m	0.26	Beach toe			
L. 10.1m	1.47		L. 30m	-0.64				
L. 19.5m	0.89		D 6	2.69	L. 37m	-0.84 RL		
L. 19m	0.12	Beach toe	L. 5m	2.81	L. 46m	-0.96 RL		
L. 35m	-0.53		L. 15m	1.90				
L. 44m	-0.66		L. 22m	0.32	Beach toe			
IP II	2.53		L. 31m	-0.70				
L. 12.6m	1.46		D 7	2.71				
L. 20.6m	0.36		L. 5.4m	2.80	Top of bank			
L. 23.9m	0.00	Beach toe	L. 14.2m	1.24				
L. 32.7m	-0.53		L. 22m	0.32	Beach toe			
L. 47.7m	-0.75		L. 36m	-0.89				
L. 61.8m	-0.79		L. 46m	-1.03				
D 1	2.64		IP I	2.61				
L. 6.3m	2.59	Top of bank	L. 7m	2.62	Top of bank			
L. 14.9m	1.40		L. 14m	1.40				
L. 21.1m	0.62		L. 21m	0.41	Beach toe			
L. 25.2m	0.28	Beach toe	L. 28m	-0.52				
L. 41m	-0.71		L. 35m	-0.85				
L. 92m	-0.84		L. 40m	-0.99				
D 2	2.49		E 1	3.02				
L. 7.8m	2.64	Top of bank	L. 5m	2.94	Top of bank			
L. 17.5m	1.28		L. 12m	1.38				
L. 23.6m	0.62		L. 20.5m	0.33	Beach toe			
L. 28.6m	0.29	Beach toe	E 2	3.00				
L. 44m	-0.76		L. 4m	3.05	Top of bank			
L. 53m	-0.85		L. 11.6m	1.36				
D 3	2.39		L. 18m	0.35	Beach toe			
L. 5.3m	3.14		E 3	3.05				
L. 11.5m	2.20		L. 2.5m	2.89	Top of bank			
L. 21.1m	1.09		L. 11m	1.85				
L. 30m	0.81	Beach toe	L. 19m	0.34	Beach toe			
L. 42m	-0.73							
L. 54m	-0.91							

Legend. Profiles labelled as per Fig. 2
 R.L. denotes reduced level (1951)
 - signs indicate below M.S.L.
 R. denotes north of traverse
 L. denotes south of traverse

LEGEND

Depth contours in metres
 --- from survey in July 1981
 --- from survey in July 1984

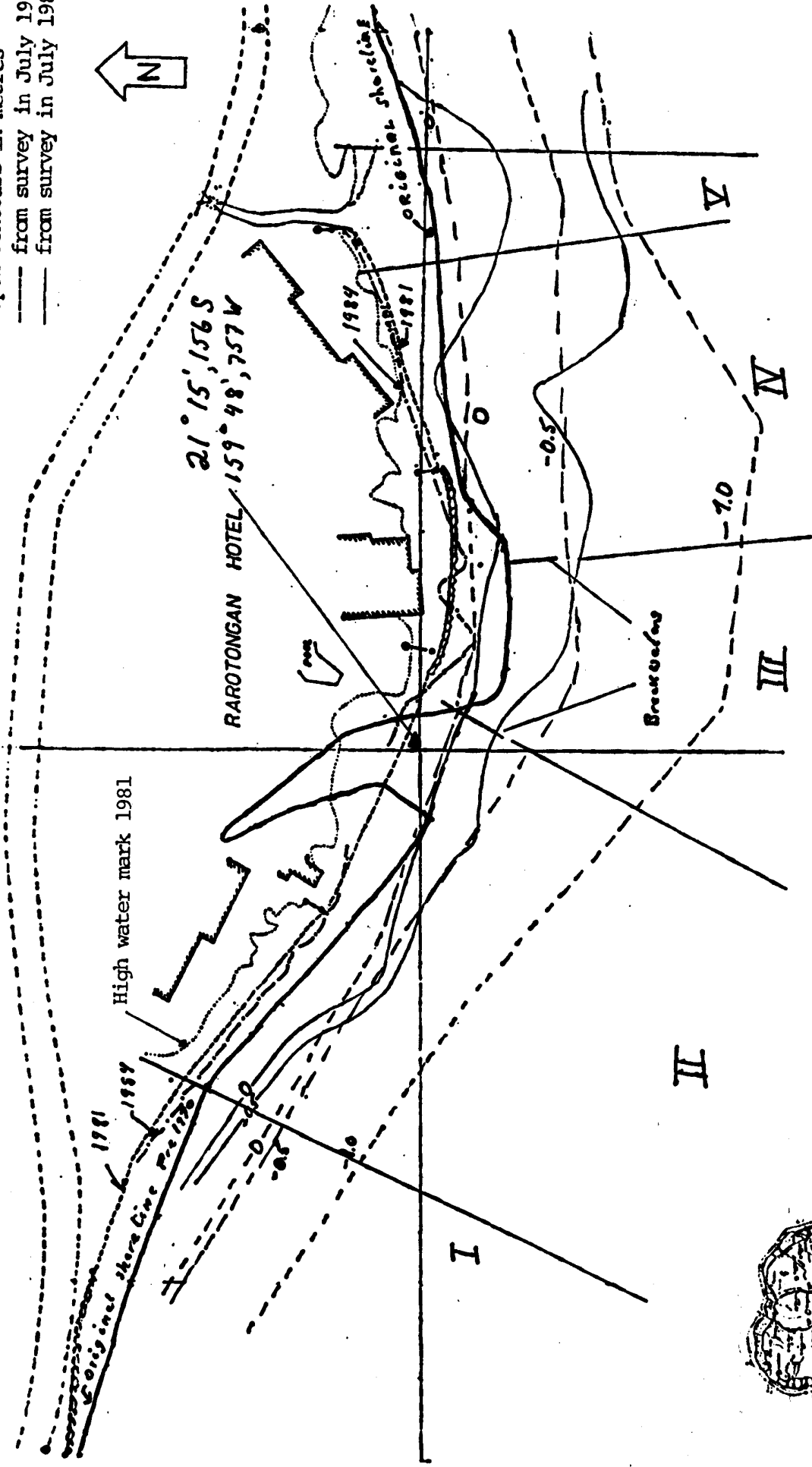

levels are in terms of BM 12 No 2, mean sea level
 Rarotonga Datum 1951.

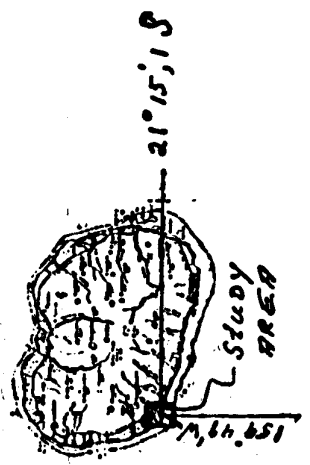
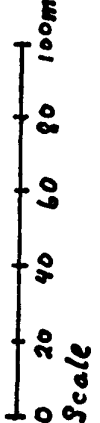

Fig. 1: Study Area

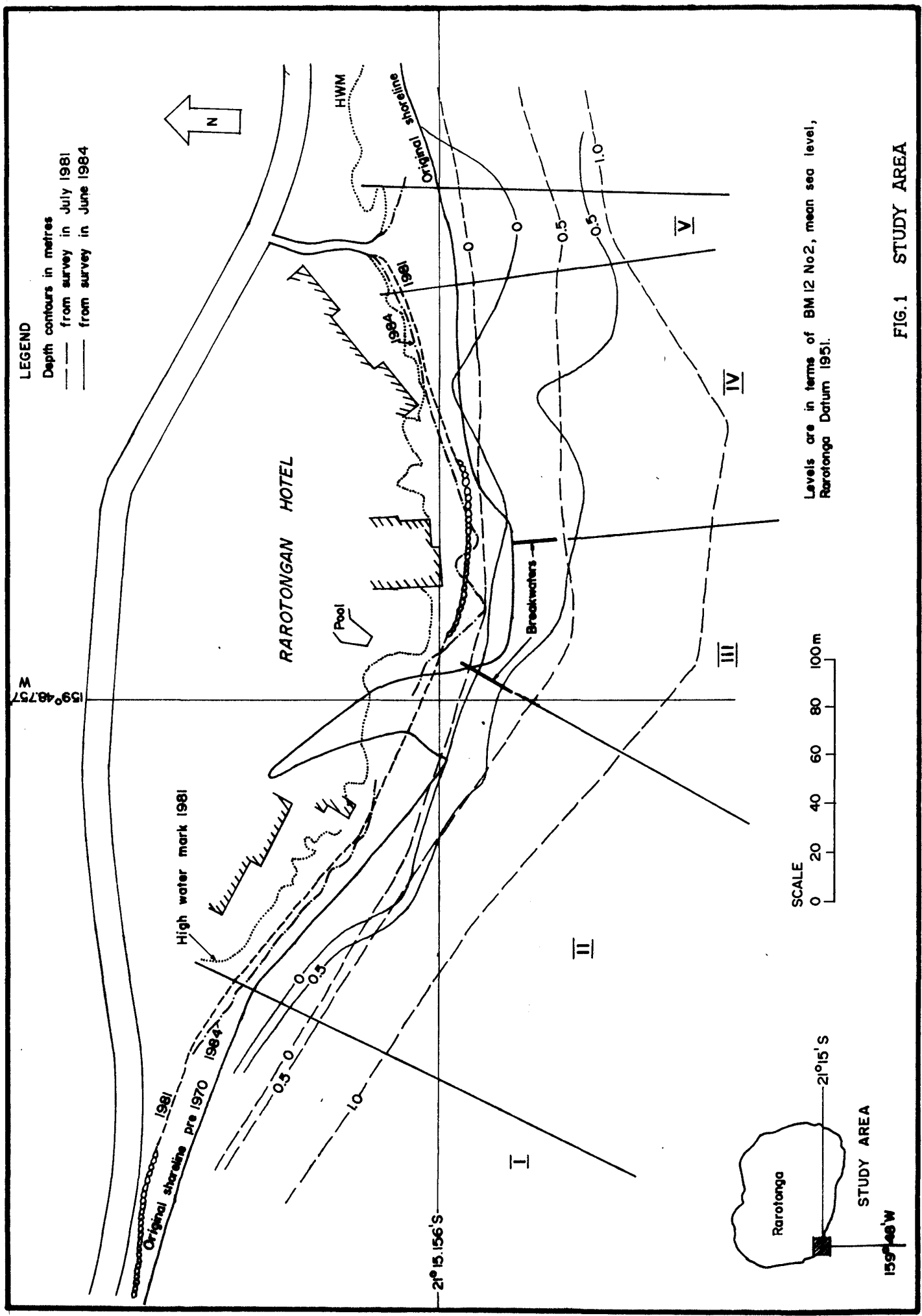

FIG.1 STUDY AREA

LEGEND

Depth contours in metres, from June 1984 survey
Levels are in terms of BM12 No2, mean sea level,
Rarotonga Datum 1951.

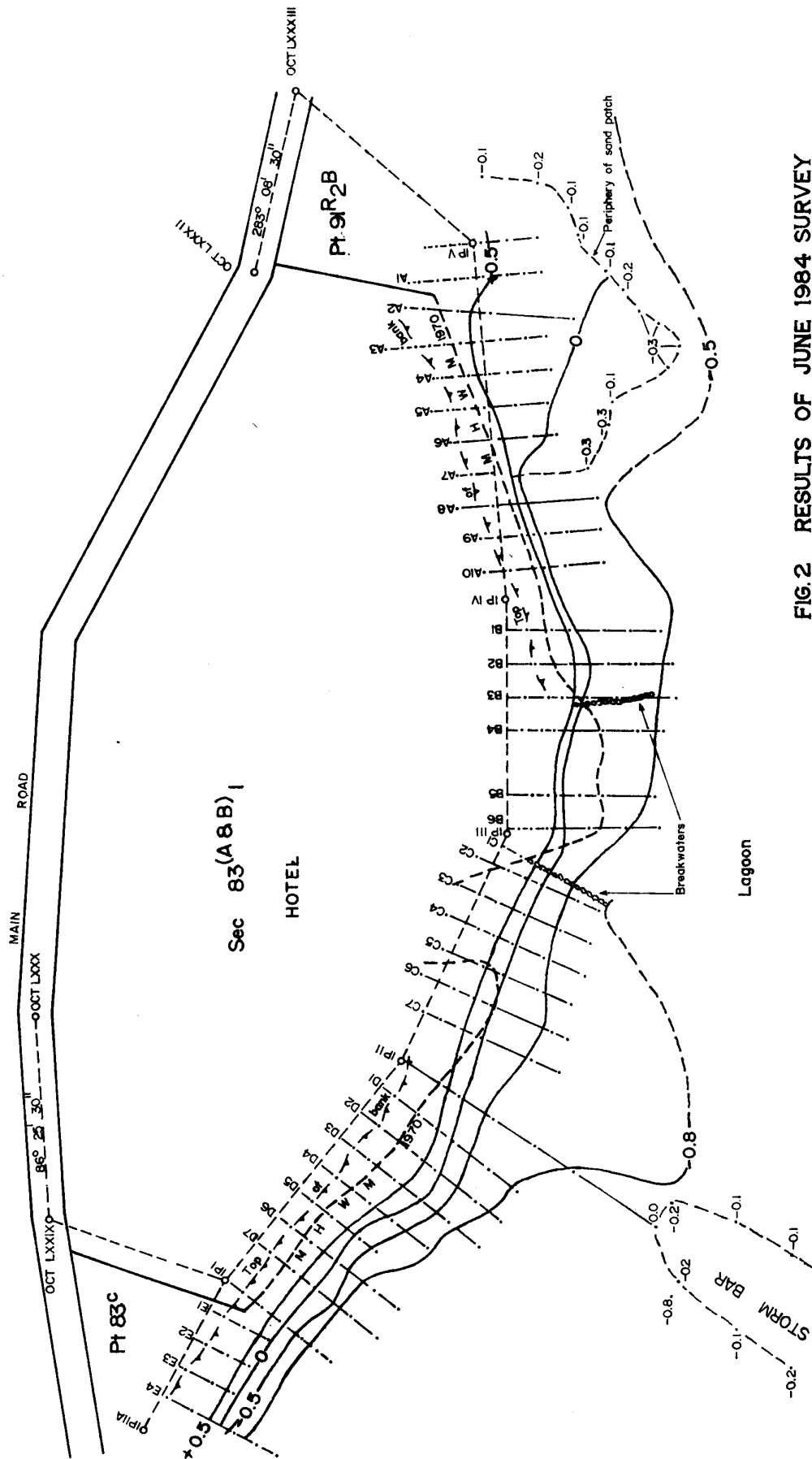
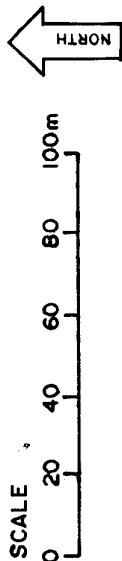

FIG 2 RESULTS OF JUNE 1984 SURVEY

TROPICAL CYCLONES

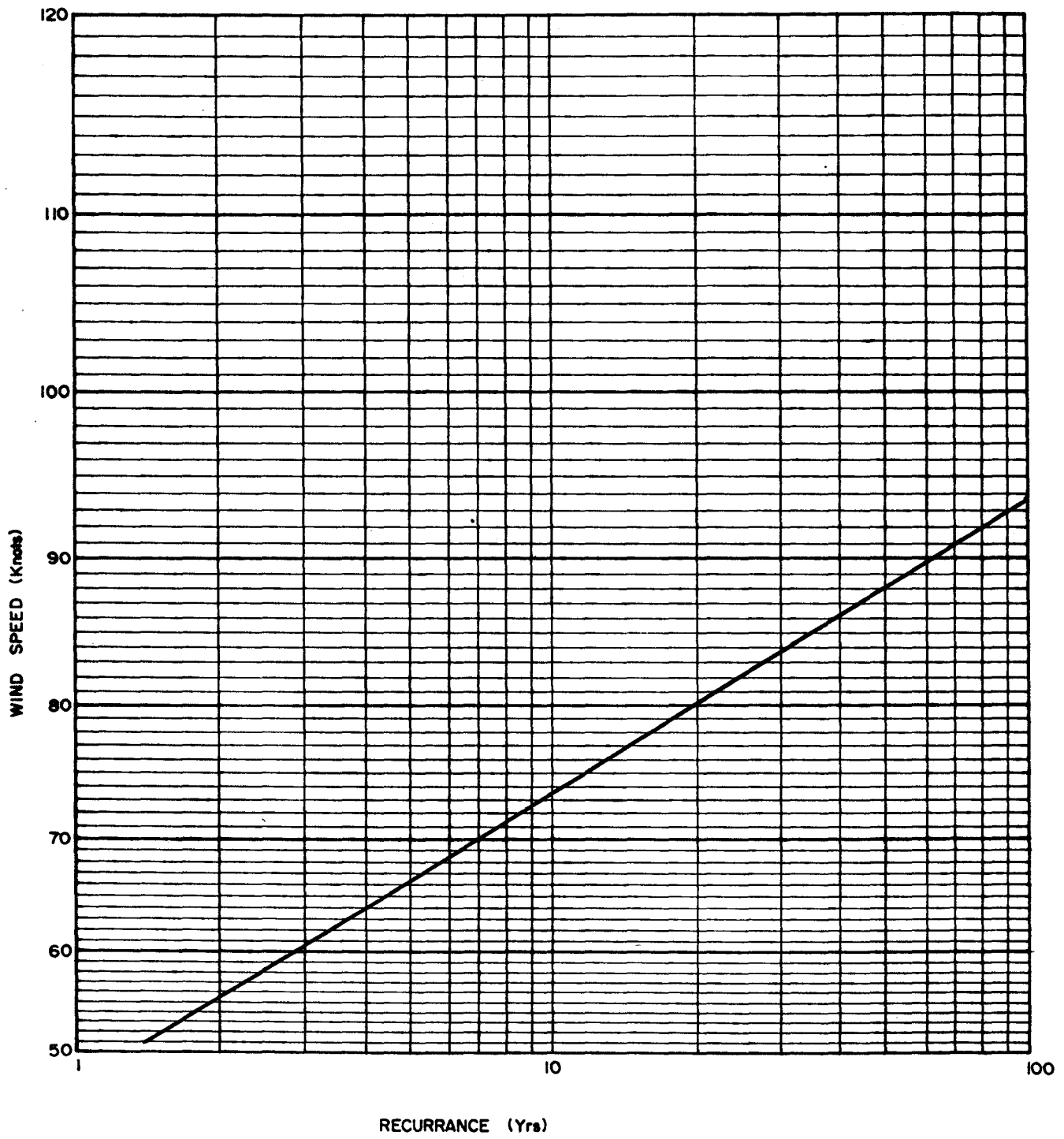

FIG. 3 PREDICTED HURRICANE RECURRENT AT RAROTONGA