

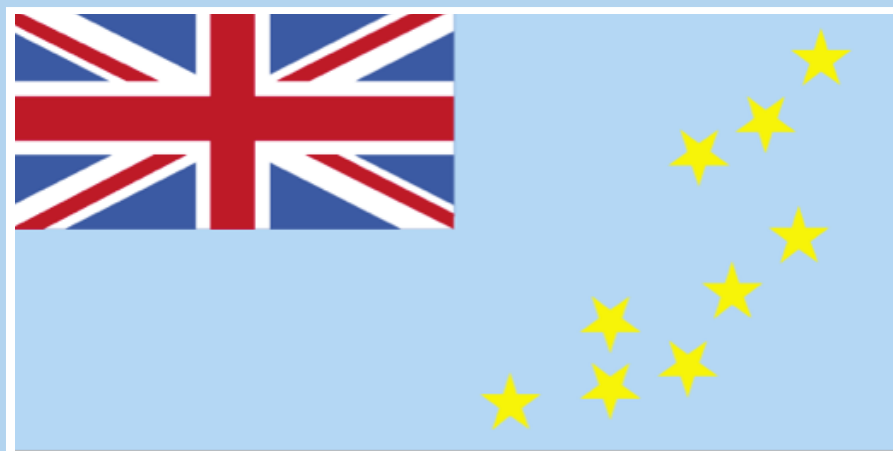

# Enetise Tutumau 2012-2020

*Master Plan for Renewable Electricity  
and Energy Efficiency in Tuvalu*



**TUVALU ELECTRICITY CORPORATION**



# Foreword

*By: The Honourable Kausea Natano, Deputy Prime Minister and Minister of Communications,  
Transport & Public Utilities*

Te “Palani mo Enetise Tutumau (Renewable Energy Master Plan)” is the outcome of the Government of Tuvalu vision made in 2008 for Tuvalu to become 100% renewable energy for all its power generation by the end of 2020.

The local name “Enetise Tutumau” is firmly embedded in the Tuvalu’s Energy Strategy with the goal to convert Tuvalu’s electricity generation from 100% diesel to 100% renewable energy.

This document is directly linked to “Te Kakeega II 2015”, “Te Kaniva (Climate Change Policy) 2012” and the “Tuvalu National Energy Policy”. This will guide the Government of Tuvalu in the development of renewable energy and energy efficiency to achieve Tuvalu’s vision. The development of renewable energy technologies is capital intensive and we do not have the resource and capacity to fulfill this vision. It is a huge challenge to the Government and with the financial support and assistance of the International Community and our Donor Partners, the vision of 100% renewable energy by 2020 can be truly achieved.

I would like to take this opportunity to express my sincere gratitude for the financial and technical assistance provided by the New Zealand Government through the Ministry of Foreign Affairs and Trade (MFAT) for this document to become a reality.



# Glossary

## **ACRONYMS**

BAU	Business As Usual
EE	Energy Efficiency
ET	Enetise Tutumau (Tuvaluan for “Steadfast Electricity”)
ETC	Enetise Tutumau Council
ECC	Energy Co-ordination Committee
GoT	Government of Tuvalu
GDP	Gross Domestic Product
IRR	Internal Rate of Return
LV	Low Voltage (230 / 400 VAC)
MV	Medium Voltage (11 kV)
MFAT	New Zealand Ministry of Foreign Affairs and Trade
NPV	Net Present Value
RE	Renewable Energy
REEEU	Renewable Energy and Energy Efficiency Unit
EEEE-EEF	EEEE Educational Equipment Facility
PPP	Purchasing Power Parity (for GDP comparison)
PRIF	Pacific Regional Infrastructure Facility
PWD	Public Works Department of Tuvalu
SIDS	Small Island Developing States
TEC	Tuvalu Electricity Corporation
TISIP	Tuvalu Infrastructure Strategy & Investment Plan
TMTI	Tuvalu Maritime Training Institute
TTC	Tuvalu Telecom Corporation

## **UNITS**

A\$	Australian Dollar (Australian dollars are used in Tuvalu as local currency)
GWh	Gigawatt hour (= 1 million kWh) (unit of electricity consumption)
kW	kilowatt (unit of power rating – output or demand)
kWh	kilowatt hour (measure of electricity consumption)
kWp	kilowatt peak (unit of peak electricity output)
MW	Megawatt (= 1000 kW) (unit of power rating – output or demand)





# Table of Contents

*ENETISE TUTUMAU 2012 - 2020*

*Master Plan for Renewable Electricity and Energy Efficiency in Tuvalu*

	Foreword	
	Executive Summary	i
<b>1.0</b>	<b>INTRODUCTION</b>	<b>1</b>
1.1	Acknowledgement	1
1.2	Tuvalu's Commitment	1
1.3	Purpose	2
1.4	Plan Objectives	3
<b>2.0</b>	<b>TUVALU'S PATH TOWARDS 100% RENEWABLE ENERGY</b>	<b>4</b>
2.1	Renewable Electricity Technology	5
2.2	Renewable Electricity Investment Programme	5
2.3	Outer Islands	7
2.4	Energy Efficiency	8
2.5	The 1000 Solar Roof Programme	8
<b>3.0</b>	<b>BACKGROUND</b>	<b>9</b>
3.1	Geography	9
3.2	Population Trends	10
3.3	Use of Electricity	11
3.4	International Comparison	13
3.5	FUTURE ELECTRICITY REQUIREMENTS	13
<b>4.0</b>	<b>EXISTING GENERATION INFRASTRUCTURE</b>	<b>15</b>
<b>5.0</b>	<b>RENEWABLE ELECTRICITY</b>	<b>17</b>
5.1	DEVELOPMENT	17
5.2	SOLAR ENERGY	17
5.3	WIND GENERATION	19
5.4	GRID STABILITY	20
5.5	DEMAND MANAGEMENT	20





# Table of Contents

*ENETISE TUTUMAU 2012 - 2020*

*Master Plan for Renewable Electricity and Energy Efficiency in Tuvalu*

<b>6.0</b>	<b>ENERGY EFFICIENCY</b>	<b>21</b>
6.1	Public Education	21
6.2	High User Energy Audits	23
6.3	Technology Improvements	24
6.4	Demand Side Management	26
<b>7.0</b>	<b>ENERGY ECONOMICS IN TUVALU</b>	<b>27</b>
7.1	Diesel	27
7.2	Solar Generation	28
7.3	Wind Generation	28
7.4	Bio-Diesel	29
7.5	Energy Efficiency	29
7.6	Economic Analysis	30
<b>8.0</b>	<b>IMPLEMENTATION STRATEGY</b>	<b>34</b>
8.1	Funding	34
8.2	Capacity Building	34
8.3	Policy and Regulations	35
	References	38
APPENDIX A	SOLAR ENERGY CONCEPTS	A
APPENDIX B	GRID ISSUES	B
APPENDIX C	RENEWABLE ENERGY PROJECTS	C
APPENDIX D	TUVALU ELECTRICITY CORPORATION DATA	D
APPENDIX E	EXTRACT FROM TUVALU NATIONAL ENERGY POLICY	E



# Executive Summary

This Master Plan outlines the way forward to generate electricity from renewable energy and to develop an energy efficiency programme in Tuvalu.

Tuvalu has two stated goals:

- To generate electricity with 100% renewable energy by 2020
- To increase energy efficiency on Funafuti by 30%.

To meet these ambitious targets, Tuvalu must develop 6 MW renewable energy electricity generation capacity in the next eight years. The initial capital cost of solar arrays, wind turbines and batteries to replace the current energy demand is estimated to be A\$52 million.

Currently Tuvalu is using 1.76 million litres of diesel fuel per year at a cost of A\$1.50/litre, most of which is used to generate electricity. By the end of 2012, the output capacity of renewable energy electricity generation using PV technology totalled 146 kW (peak) with a further 66 kW expected to be commissioned early 2013. However, in terms of electricity production, diesel generation still provides 95% of the total. Large scale conversion to renewable electricity and implementation of energy efficiency improvements will reduce the diesel demand. Given the steady and continuing increase in the price of diesel oil, the renewable electricity and energy efficiency programme will not only be cost effective but will ensure that affordable electricity is available to the people of Tuvalu.

It is estimated that following the completion of the renewable electricity and energy efficiency programme, the use of the diesel generator plant will reduce by up to 95% with a consequent reduction in diesel fuel consumption. Savings in diesel fuel over the 30 year life of the overall programme are estimated to be A\$152 million (2011 dollars) assuming oil prices continue to increase at the current long term trend. After allowing for battery replacements and other maintenance, which are estimated to cost A\$115 million, the net saving over the 30 year programme will be A\$37 million.

## **Renewable Energy Programme**

To meet the above objectives, electricity will be generated using renewable energy in all the nine islands of Tuvalu. The Outer Islands<sup>1</sup> will be developed as a priority because fuel transportation from Funafuti increases the cost of generation and has environmental risks associated with potential fuel spill. Furthermore, the Outer Islands generate 18 hours a day (rather than 24 hours) and the power systems are less reliable.

On Fogafale, the main island of Funafuti atoll, due to the high population density, available land is scarce and ground-mounting of the proposed photovoltaic (PV) arrays that will form the major component of the renewable electricity system is not considered practicable. In order to provide the required area for the PV arrays, in 2011 the General Manager of the Tuvalu Electricity Corporation (TEC) announced the “**1000 Solar Roof Programme**”. In this programme, about half of the current roof space of the buildings in Funafuti will be occupied by PV arrays. In the case of the Outer Islands where more ground space is available, it is likely that a mix of roof mounted and ground mounted arrays will be adopted.

<sup>1</sup>The term “Outer Islands” refers to the islands and atolls of Tuvalu other than Funafuti Atoll.



# Executive Summary

Initially the renewable electricity programme in Funafuti will comprise of the installation of PV arrays with battery storage because this technology is well proven in Tuvalu. In the early stages of the programme, a detailed investigation will examine the feasibility of wind turbine generation in Funafuti as wind generation could offer significant technical and economic benefits. Subject to no insurmountable problems being identified, wind turbines will be installed from about 2015 onwards as a wind-solar mix will optimise the level of battery storage required and the level of diesel generation required.

The system will require standby diesel generation to provide a back-up to the renewable energy when prolonged weather conditions limit renewable energy generation. Conversion or replacement of the existing diesel generators to run on bio-diesel fuel is proposed to take place in the last stage of the renewable electricity programme. It is estimated that 5% of the annual electricity production will be supplied from bio-diesel generation.

## ***Energy Efficiency Programme***

Energy efficiency improvements will be initially targeted on Funafuti. Funafuti has a higher power demand per capita than the outer islands and also consumes 85% of the electricity generated by the Tuvalu Electricity Corporation (TEC). Meeting the 30% target will allow Tuvalu to maintain current generation levels over the next eight years at 2% annual growth of GDP. The energy efficiency programme will include public education, energy audits and technology improvements.

## ***Programme Support***

The TEC will increase resources and capacity to manage the capital investment programme. During the implementation of the programme, TEC will increase staff numbers by up to 10 to undertake project management, administration, and promotion activities.

Full government support will be necessary to facilitate a smooth implementation. This support will include setting policy and passing legislation, and promulgating rules and regulations. The 1000 Solar Roof Programme will need particular support from the Government and new policies around access and ownership. As a first step, in 2012, the Cabinet gave approval for the use of the government building rooftop for the installation of PV arrays.

## ***Funding***

In order to enable a planned approach to implementation, Tuvalu is seeking a steady funding stream and a long-term commitment by donors for the investment plan. The funding could be arranged as co-funding amongst a group of nations. The estimated finance is A\$6.5 million per year from 2013 to 2020.





1.0

# Introduction

## 1.1 Acknowledgement

The Government of Tuvalu and the Tuvalu Electricity Corporation (TEC) gratefully acknowledge the funding of this Plan by the New Zealand Ministry of Foreign Affairs and Trade (MFAT). The Government of Tuvalu and the Tuvalu Electricity Corporation also acknowledge the contribution of the Secretariat of the Pacific Community (SPC), the Pacific Island Advisory Centre (PIAC) and the Deutsche Gesellschaft fuer Internationale Zusammenarbeit (GIZ) to the review and finalisation of the Master Plan. The Government of Tuvalu and the Tuvalu Electricity Corporation (TEC) also acknowledge the input of AECOM New Zealand in the preparation of this Plan.

## 1.2 Tuvalu's Commitment

In his statement to the 55th Session of the UN General Assembly on 5 September 2000, on the Admission of Tuvalu to the United Nations, the late Prime Minister of Tuvalu, The Hon. Ionatana Ionatana said:

*"...We are concerned about global climate change, and the consequences of atmospheric warming, in particular rising sea levels. World-wide, carbon dioxide emissions are still increasing. Emission targets are not being met. We urge the members of the United Nations family, in accordance with the Kyoto Protocol, to combat this threat more aggressively...before it is too late. ...In joining the United Nations, we want to build a stronger international identity. We want to strengthen old friendships and forge new relationships with Member States far and wide. We will uphold the noble ideals of the UN, and pledge our contribution to the promotion of progress, prosperity, and peace. ..."*

The Tuvalu National Energy Policy, 2009 states:

*"By the year 2020, guided by the principles in the "Te Kakeega II" and the "Malefatunga Declaration", Tuvalu shall attain a prosperous living standard that is fostered through an energy policy that promotes the provision of socially, financially, economically, technically, politically and environmentally sustainable energy systems and [is] within the framework of the Tuvalu Initial National Communication under the United Nations Framework on Climate Change (Oct 1999)."*

At a Ministerial Conference of the Alliance of Small Island States (AOSIS) on "Achieving Sustainable Energy for All in SIDS – Challenges, Opportunities, Commitments" in Bridgetown, Barbados, May 7-8, 2012, the Minister of Communications, Transport and Public Utilities, The Honourable Kausea Natano, communicated his vision and Tuvalu's commitment as follows:

*"Tuvalu, in partnership with the Governments of Australia, Denmark, New Zealand, Norway, the United Kingdom, and UNDP commits itself to:*

*a) Power Generation – 100% renewable energy by 2020*

*b) Implementation Principles:*

- Photovoltaic (PV)- 60 – 95% of demand*
- Wind 0 – 40% of demand (if feasible)*
- Bio-diesel 5% of demand (import)*
- Energy Efficiency – improvements of 30% of current annual demand of Funafuti."*



# 1.0

## Introduction

This commitment was endorsed by the Prime Minister of Tuvalu, The Hon. Willy Telavi, at the Rio+20 Conference in June 2012, and it is a priority for the nation. Tuvalu is now calling for its development partners to stand by the nation and assist in the implementation of the Tuvalu Energy Policy and in the achievement of 100% renewable energy-based electricity generation by 2020.

Renewable Energy has a high profile with donors and within Tuvalu, and is a cornerstone of Tuvalu's development objectives. The Pacific Regional Infrastructure Facility (PRIF) confirmed in its Tuvalu Infrastructure Strategy & Investment Plan (TISIP) Report (2012) the priority of the power sector development until 2016 with the Energy Sector projects P3 and P2 ranking number 1 and 2 priority respectively.

### **1.3 Purpose**

This Master Plan outlines the way forward to generate electricity from renewable resources ("renewable electricity") and to develop an energy efficiency programme in Tuvalu. This Master Plan is intended for use by the Government of Tuvalu (GoT), the Tuvalu Electricity Corporation (TEC), potential donors, community representatives and other relevant stakeholders. It is a working document and will be regularly reviewed and updated as new information becomes available. The purpose of this document is to:

- a) Outline the technical concepts;
- b) Review the economic feasibility; and
- c) Propose an implementation programme.

The Master Plan is the first step in the process that will lead to implementation and will be followed by (in order):

- Pre-Feasibility Studies that will review the technical concepts and economic feasibility, and identify the least-cost options to achieve the stated goals in the Master Plan.
- Feasibility Studies that fully evaluate and confirm the least-cost options identified in the Pre-Feasibility Studies - including economic feasibility and preparation of a detailed implementation programme.
- Implementation.



# 1.0

## Introduction

### **1.4 Plan Objectives**

Renewable Energy and Energy Efficiency (REEE) are at the centre of this Master Plan. Energy efficiency is included because the reduced electricity demand from energy efficiency measures will result in a reduced requirement for new generation capability thereby reducing both capital and operating costs. Typically this can be expected to provide good cost-benefits and maintain the affordability of electricity to the people of Tuvalu. Due to the low energy demand of the Outer Islands, it is proposed that the focus of the energy efficiency programme should commence on Funafuti where electricity consumption is relatively high, followed by progressive and rapid implementation on the Outer Islands.

The priorities for the electricity sector in Tuvalu are:

- a) To provide a reliable and affordable electricity supply to all the people of Tuvalu;
- b) To safeguard Tuvalu from future diesel price shocks;
- c) To improve the efficiency of electricity utilisation and further reduce the already low energy consumption per person and per GDP; and
- d) To reduce Tuvalu's "carbon footprint" and become an international role model with regard to climate change mitigation.





# 2.0

## Tuvalu's Path towards 100% Renewable Energy

As a first step in a path towards 100% renewable energy, the G.O.T has set two goals:

- To generate electricity using 100% renewable energy by 2020
- To increase energy efficiency by 30% on Funafuti and later in the Outer Islands.

This Master Plan provides the framework for the achievement of these goals, which it is estimated will require a total renewable electricity generation capacity of 6 MW involving a capital investment of A\$52 million.

By the end of 2020, the objective of the renewable electricity generation programme is that 95% of total electricity needs will be supplied from a mix of solar and wind energy sources. The percentage to be provided by each of the two technologies is still to be determined, but the initially, new generation is expected to be PV while wind generation is further investigated.

There will be a requirement for supplementary generation to provide a back-up to the renewable electricity generation when prolonged weather conditions limit electricity generation from PV or wind. Subject to technical and economic feasibility, conversion or replacement of existing diesel generators to run on bio-diesel is planned to take place during the last stage of the renewable electricity programme. It is estimated that 5% of the annual energy demand will be supplied from bio-diesel in 2020.

Risks include the failure to meet the energy efficiency targets set out in this Master Plan or significant growth in GDP, either of which will require either increased investment in renewable electricity generation over that included in this Master Plan, or continued reliance on diesel generation.

The key elements of the renewable electricity programme are:

- 1) Development of renewable electricity generation supplemented with batteries initially on the Outer Islands ;
- 2) The provision of additional renewable electricity generation capacity on Funafuti;
- 3) The implementation of an energy efficiency programme on Funafuti initially followed by a programme on the Outer Islands;
- 4) Conversion of supplementary generation from diesel to bio-diesel fuel.

The chosen renewable energy and energy efficiency technologies will be:

- Safe, proven, reliable and sustainable;
- Consistent in type wherever possible to simplify operations, maintenance and spare parts management;
- Cost-effective over the technical life of the equipment; and
- Socially, environmentally and culturally acceptable.



## 2.0

# Tuvalu's Path towards 100% Renewable Energy

### **2.1 Renewable Electricity Technology**

PV generation has been in operation in Funafuti since 2008 and in Vaitupu since 2009 and the performance of the generation plant has been satisfactory.

The wind resource has been assessed on Funafuti and is now being assessed in Nukufetau. It is recognised that a mix of PV and wind generation would have the potential to minimise the level of battery storage and use of generation from diesel or biodiesel fuels. Initial studies indicate wind turbines can also offer a sound economic option but that a number of technical and environmental issues need to be investigated. These issues will be investigated over the period 2013 to 2015 including further wind monitoring and if favourable, wind generation will commence during 2015.

### **2.2 Renewable Electricity Investment Programme**

The programme was developed taking into consideration the following:

- a) To be initially designed to cover the existing energy demand assuming energy efficiency improvements;
- b) Steady funding streams being available from 2013 to 2020;
- c) The introduction of renewable electricity on the Outer Islands a priority for economic and environmental reasons as discussed in 2.3 below.

The Renewable Electricity programme above shows the existing installations as of 2012, and also those planned for installation during the period 2013 to 2020. Details are provided in the table on the following page.



## 2.0

# Tuvalu's Path towards 100% Renewable Energy

**Table 2-1 Description of Annual RE Installations**

PERIOD	PROGRAMME
2012	<ul style="list-style-type: none"> <li>- 66 kWp grid-connected PV for the desalination plant in Funafuti (funded by Japan) – under construction.</li> <li>- 40 kWp grid-connected PV, Funafuti (Russia funded)</li> <li>- 9kWp solar PV standalone for desalination plant in Funafuti (funded by AUSAid/UK/USA – completed)</li> </ul>
2013	<ul style="list-style-type: none"> <li>- Phase 1: Outer Islands PV generation with battery storage and diesel backup – Nukulaelae, Nukufetau, Nui</li> <li>- Phase 2: Outer Island PV generation with battery storage and diesel backup – Nanumea, Nanumaga, Niutao.</li> <li>- Phase 2: Funafuti 1 PV generation with central battery storage (~ 600 kWp)</li> <li>- Phase 2: Wind generation investigation on Funafuti.</li> <li>- 4 kWp PV array on demonstration fale in Funafuti (funded by UNDP (SIDS-DOC)</li> </ul>
2014	<ul style="list-style-type: none"> <li>- Completion of Phase 1 Outer Island PV.</li> <li>- Completion of Phase 2 Outer Island PV</li> <li>- Completion of Phase 2: Funafuti PV generation.</li> <li>- Further grid-connected PV generation in Funafuti.</li> <li>- 12 kWp PV supplying an institution (TMTI) located on Funafuti (Finland funded).</li> </ul>
2015	<ul style="list-style-type: none"> <li>- Outer Islands PV generation – Phase 3: third stage of PV generation on Vaitupu (PV with battery storage).</li> <li>- Outer Islands PV generation – Phase 3: PV generation on Niulakita.</li> <li>- ~300 kW wind generation on Funafuti</li> </ul>
2016 to 2020	Up to 750 kWp of renewable electricity generation capacity each year on Funafuti, comprising PV and possibly wind generation.

Funding this programme as one package rather than as a series of individual packages will provide Tuvalu with a steady funding stream and a long-term commitment by donors for the implementation of the investment plan. The funding could be arranged as co-funding amongst a group of nations. The estimated finance is A\$6.5 million per year from 2013 to 2020. If this combined sum is not available, Tuvalu will need to adopt a flexible programme to reflect local GDP development and donor conditions.

Figure 2.1 over represents the programme in terms of the cumulative total of renewable electricity capacity installed.





2.0

# Tuvalu's Path towards 100% Renewable Energy

## 2.3 Outer Islands

Priority is to be given in the renewable electricity programme to implementation on the Outer Islands for the following reasons:

- Transporting the diesel fuel now used for electricity generation is expensive as it has to be transported in drums.
- The risk of diesel spill during the ship to shore handling process is high.
- To reduce the cost of generation, the supply is now turned off for a period overnight.

While the capital investment required on a per capita basis is higher on the Outer Islands than on Funafuti owing to the logistics of implementation, the electricity demand of the Outer Islands is only 16% of the national total and has relatively little impact. While it is anticipated that the availability of 24 hour electricity will result in an increase in electricity consumption per capita, it is assumed that this will be counter-balanced by the energy efficiency programme.

The generation systems in the Outer Islands must be reliable and use simple and proven technology. Equipment will be modular using “off the shelf” components, safe to operate and capable of remote monitoring by TEC from Funafuti. The system installed in Vaitupu in 2009 has these characteristics. A common technology will be adopted for all of the Outer Islands using PV generation with battery storage with the existing diesel generators providing the necessary back-up (solar-battery-diesel hybrid) and the design will be based on the mini-grid model design developed for MFAT. The existing distribution systems will be retained.

**Figure 2-1 Cumulative total of renewable electricity capacity installed.**

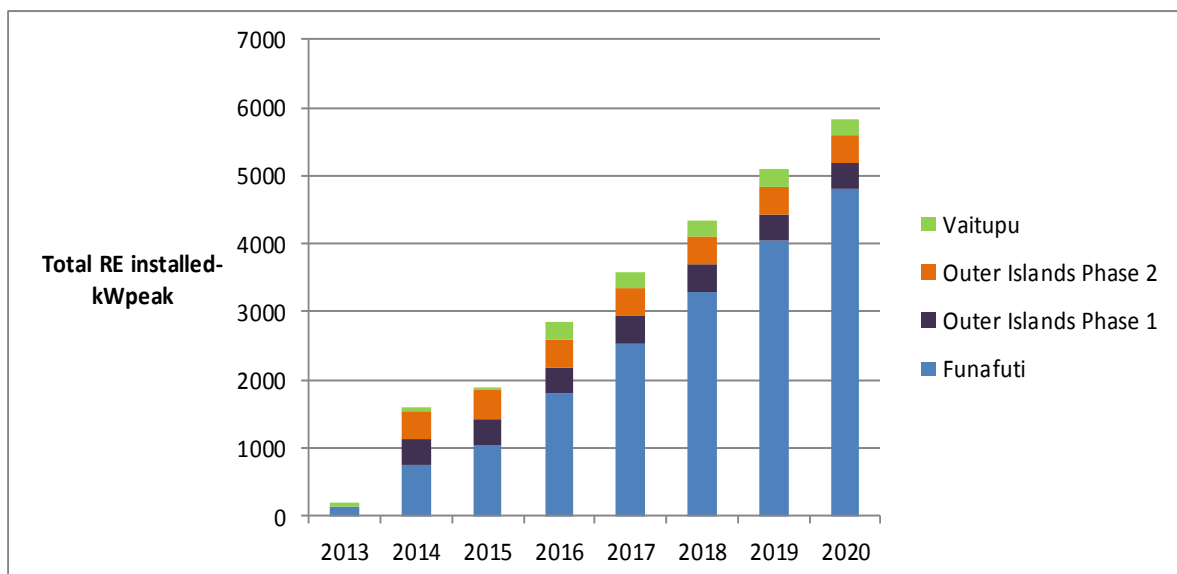



2.0

# Tuvalu's Path towards 100% Renewable Energy

## 2.4 Energy Efficiency

Funafuti will be the initial target for energy efficiency improvements. Funafuti has a higher power demand per capita than the outer islands and also consumes about 85% of the electricity generated by TEC. Furthermore, it will be easier for energy efficiency capability to be developed on Funafuti and that capability made available for the progressive introduction of energy efficiency programmes on the Outer Islands. Meeting the 30% target will allow Tuvalu to maintain current generation levels over the next eight years at 2% annual growth of GDP.

The Energy Efficiency programme will consist of public education, energy audits, practical demonstrations and technology improvements.

## 2.5 The 1000 Solar Roof Programme

A central component of this Master Plan is the 1000 Solar Roof Programme, which was announced in 2011 by the General Manager of TEC. Due to the high population density in Funafuti, there is insufficient land unavailable for ground-mounting of PV arrays. Therefore, in order to meet the anticipated electricity generation requirements, it is estimated that about half of the roof space of the approximately 1,000 buildings in Funafuti will need to be used for the installation of the PV arrays. If affordable electricity is to continue to be available in the future then this is a simple benchmark that people can relate to and helps TEC demonstrate to its customers the relevance and importance of this technology.



Potential "solar roofs" in Funafuti

High efficiency solar modules, using on mono- or poly-crystalline technology with approximately 140 W/m<sup>2</sup> peak generation capacity are proposed for Funafuti to reduce the required area for the solar arrays.

About 95% of the roofs in Funafuti are clad with corrugated iron with minimum structural support and are unlikely to meet cyclone-proof criteria. It is likely that most of the roofs in Funafuti where it is planned to install PV modules, will need to be structurally reinforced or replaced with heavier roofs capable of supporting the PV modules, and to meet cyclone criteria. In parallel with the preparation of this Master Plan a building survey has been carried out to assess the level of building strengthening work necessary. The findings are summarised in Appendix A. This is a significant social, economic and environmental impact, which will require community consultation and support. Legislation will also be required to address land ownership and access issues that will arise with the programme.



Announcement of "Tuvalu 1000 Solar Roof Programme" at TEC in 2011

TEC is installing some demonstration roof installations in 2012/13.



# 3.0

## Background

Figure 3-1 Map showing location of Tuvalu



### 3.1 Geography

Tuvalu, formerly known as the Ellice Islands, is located about 1,200 km north of Fiji. It is a sovereign nation country consisting of nine low-lying atolls and islands and the population are mainly of Polynesian ethnicity. This is reflected in the culture and customs of Tuvalu. Being only four metres above sea level at its highest points, Tuvalu is vulnerable to the impact of rising sea levels caused by global warming.

Tuvalu lies within the trade wind zone but on the edge of the South-west Pacific equatorial doldrum zone. Wind speeds are typically in the order of 10 knots. Although tropical cyclones occasionally develop in the vicinity of Tuvalu, hurricane force winds are rare in Tuvalu. However, while rare, destructive cyclones have been experienced in Tuvalu and cannot be discounted in the future.





# 3.0

## Background

Temperatures are uniformly high all year round with the mean annual temperature approximately 28 deg C. Sunshine hours are shown in the following chart.

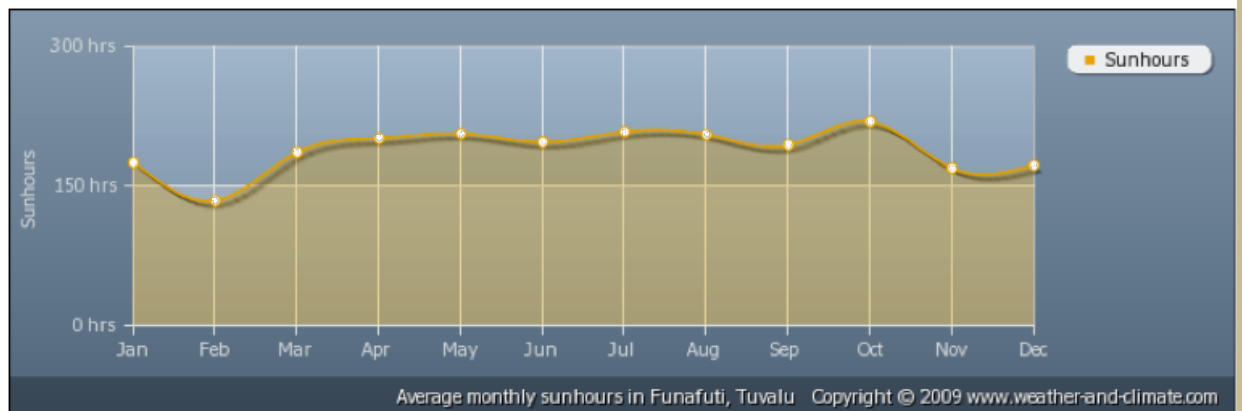

Further details are on:

<http://www.weather-and-climate.com/average-monthly-Rainfall-Temperature-Sunshine,Funafuti,Tuvalu>

### 3.2 Population Trends

The majority of the population of Tuvalu live on Funafuti owing to a steady migration from the Outer Islands and an overall natural population growth.

Figure 3-2 Population trends in Tuvalu

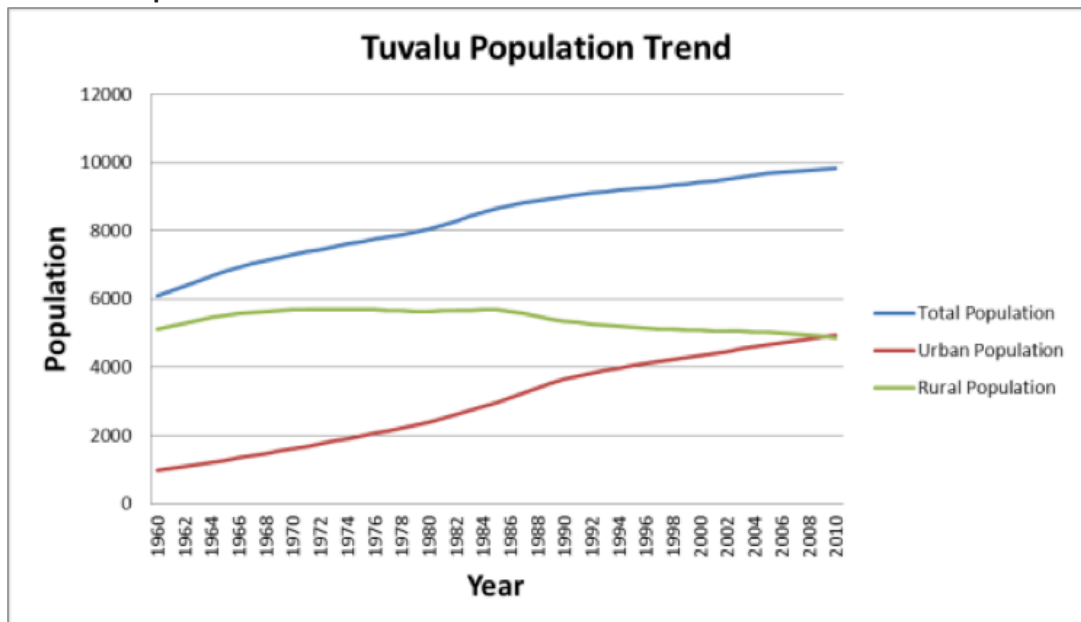



# 3.0

## Background

There is a discrepancy between population figures recorded by the World Bank Database, CIA Factbook and the Tuvalu Electricity Corporation. Population figures (2011) from the World Bank <sup>2</sup> have been used in the analysis of this report.

### 3.3 Use of Electricity

The dependence of the Tuvaluan people on electricity in their daily lives has only developed since the 1980s when electricity became widely available. Electricity has now become an essential requirement for electronic communications, refrigeration and air conditioning. Electricity consumption varies across Tuvalu with per capita consumption on Funafuti being approximately five times that of Outer Islands. Table 3-1 over refers to this.

Figure 3.3 over shows the increase in electricity generated in Tuvalu over the last 15 years. Over this period, the population of Tuvalu has grown at 0.4% per annum, GDP by an average of 3% per annum and energy use by around 6% per annum. The rate of energy use per GDP has also grown in this period.

The apparent growth of electricity consumption in 2010 was mainly attributed to improved metering and a new billing system that TEC introduced in that year.

**Table 3-1 Electricity Demand and Supply by Tuvalu’s Nine Atolls and Islands – 2010**

Atoll	Population	Land area (km <sup>2</sup> )	Population density (persons/km <sup>2</sup> )	Peak Generation (kW)	Annual Generation (kWh)	Electricity use per person (kWh)
Funafuti	5,156	2.79	1,848	1000	4,997,501	969
Nanumea	779	3.87	201	37	110,280	142
Nanumaga	687	2.78	247	37	115,000	167
Niutao	773	2.53	305	39	110,000	142
Nui	618	2.83	218	31	120,000	194
Vaitupu	1863	5.60	332	95	293,876	158
Nukufetau	688	2.99	230	38	120,000	174
Nukulaelae	457	1.28	357	20	70,000	153
Niulakita	41	0.42	98			
<b>TOTAL</b>	<b>11,062**</b>	<b>25</b>	<b>442</b>	<b>1,297</b>	<b>5,936,657</b>	

\*\* 2007 population

Source: Tuvalu Electricity Corporation

<sup>2</sup> From <http://data.worldbank.org/country/tuvalu>



3.0

# Background

Figure 3-3 Power Generation vs GDP and Population

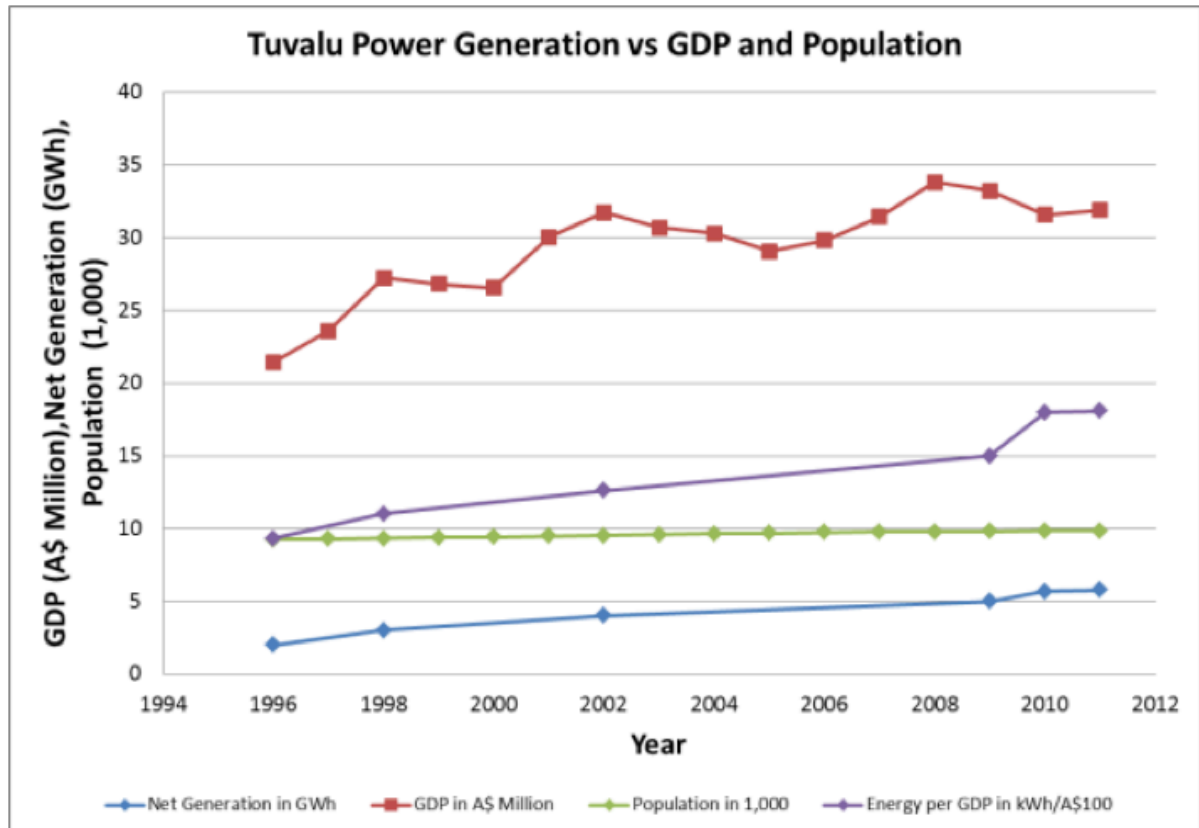





# 3.0

## Background

### 3.4 International Comparison

Figure 3.4 compares electricity consumption in Tuvalu with that of other neighbouring South Pacific island countries. It is noted that per capita electricity consumption in Tuvalu is in the same order as for Samoa and Tonga.

Figure 3-4 Comparative Electricity Consumption Data for South Pacific Island Countries

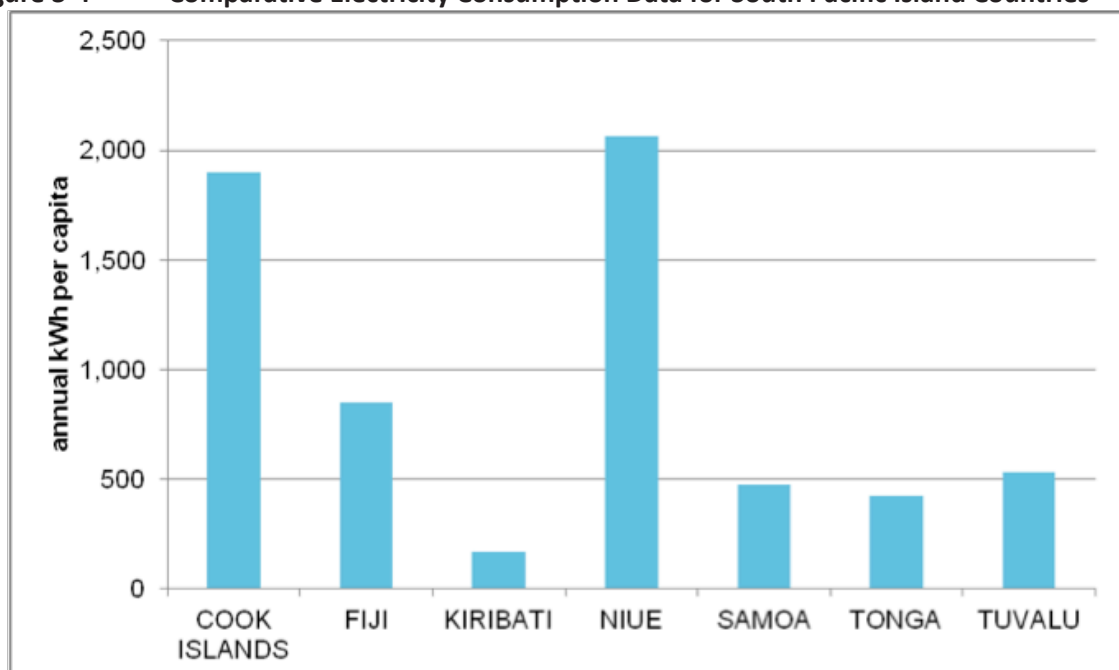

Sources: Cook Islands Statistics Office (2012), Fiji Islands Bureau of Statistics (2010), Kiribati National Statistics Office (2012), Niue Statistics (2012), Samoa Bureau of Statistics (2012), Tonga Department of Statistics (2012), Tuvalu Central Statistics Department (2008), Tuvalu Electricity Corporation.

### 3.5 Future Electricity Requirements

The future electricity demand will depend on a number of factors including:

- Population;
- Availability of supply on Outer Islands;
- Growth of income (GDP);
- Use of electricity;
- Affordability of appliances; and
- Electricity tariffs.

Historically, electricity usage increased at an average rate of 0.14GWh per year between 2002 and 2009. If the trend continued, electricity usage would increase to 7.2GWh by 2020 and 10GWh by 2030.



# 3.0

## Background

The Government of Tuvalu has an energy efficiency target to increase energy efficiency in Funafuti by 30% over the next eight years. If successful, this programme could result in a nil increase in electricity demand over the period and electricity usage would remain at 6GWh in 2020. This is equivalent to saving 1.5 million kWh of generated electricity in eight years at the current GDP.

This is an ambitious target considering that in the past electricity demand has grown at a rate of about 6% per annum, while GDP only grew at about 2.5%. If the projected saving cannot be achieved, more renewable energy capacity will be needed.

The following graph shows the Master Plan Electricity Forecast based on this saving against the 'business as usual' forecast if no energy efficiencies are made. The graph also depicts the change from diesel generation to renewable energy generation over the next eight years as the programme is implemented.

**Figure 3-5 Electricity Forecast**

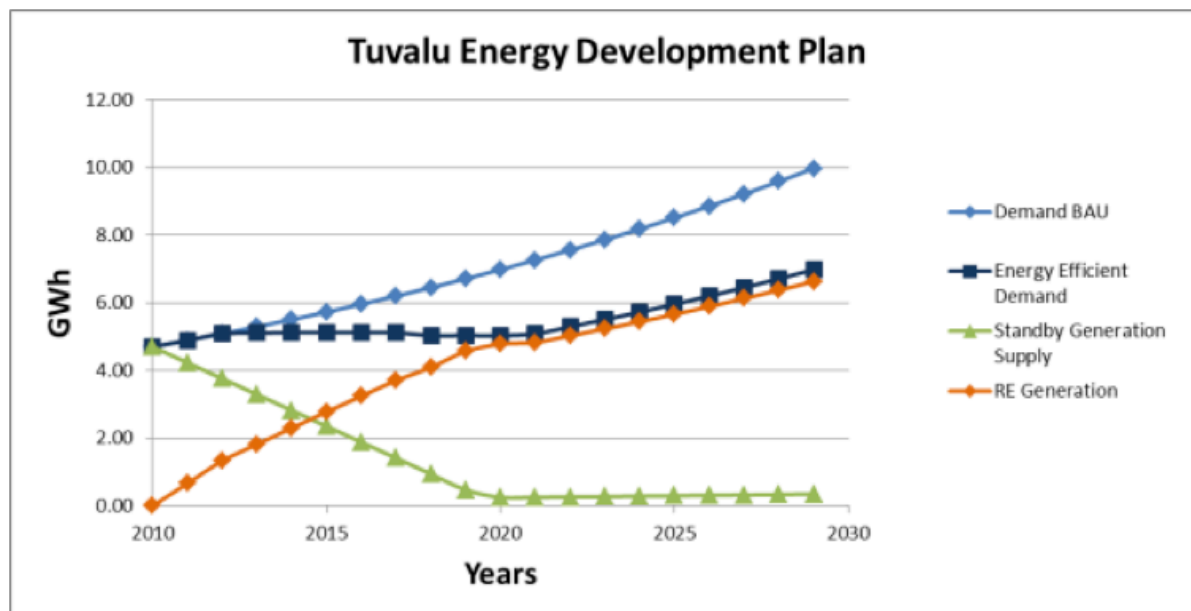



# 4.0

## Existing Generation Infrastructure

Tuvalu’s current electricity systems consist of centralised diesel generators with associated medium and low voltage distribution networks. All central electricity generators and distribution networks are owned and operated by the Tuvalu Electricity Corporation (TEC).

The distribution networks on Funafuti and Vaitupu are made up of medium voltage (11 kV) and low voltage (400/230 V) systems while the systems on the remaining islands are low voltage only. An exception is the smallest island, Niulakita, where the supply to the 40 inhabitants is limited to a number of solar modules used for the charging of batteries. One islet of the Funafuti Atoll, Amatuku, where Tuvalu Maritime Training Institute (TMTI) is located, is supplied by a diesel generator while the four families living on another islet of the Funafuti Atoll rely on solar modules to meet the needs of low energy equipment.

**Table 4-1 Existing Key Power Systems**

Atoll	Existing Power Systems	Age	Existing distribution network	Net generation (kWh)	Fuel Consumed (1000 l)
Funafuti	3 600kW Generator Sets	Dec 2006	11kV and 230/400V AC networks	4,997,500	1,423
Nanumea	3 generator sets	Dec 1999	230/400V AC Network	110,280	45
Nanumaga*	3 generator sets	Dec 1999	230/400V AC Network	115,000	45
Niutao*	3 generator sets	Jan 2000	230/400V AC Network	110,000	49
Nui*	3 generator sets	Nov 1999	230/400V AC Network	120,000	47
Vaitupu	3 generator sets	Nov 1999	11kV and 230/400V AC networks	293,876	81
Nukufetau*	3 generator sets	Nov 1999	230/400V AC Network	120,000	42
Nukulaelae*	3 generator sets	Oct 1999	230/400V AC Network	70,000	31
Niulakita			No island network		
<b>Diesel Total</b>				<b>5,936,657</b>	<b>1,763</b>
Vaitupu	46 kWp hybrid PV/battery/diesel	2009	230/400 VAC	69,800	-
Funafuti	40kWp PV array	2008	230 / 400 VAC	60,400	-
Funafuti	42kWp PV array	2012	230 / 400 VAC		
Funafuti	66kWp PV array associated with desalination plant	Under construction	Note. This plant is not yet installed		
Funafuti	9 kWp PV array	2012	Standalone		
<b>PV Total</b>				<b>130,200</b>	

\*Estimated energy values

Source: Tuvalu Electricity Corporation





4.0

## Existing Generation Infrastructure

Currently it is assessed that annually 130,000kWh are generated by the two existing PV arrays which amounts to approximately 2% of total generation. No data is yet available for the 2012 PV installations.

TEC propose to install a generator load dispatch system at the Fogafale power generation station. This software controlled system is expected to improve the fuel efficiency of the diesel generators, translating into direct cash savings for TEC. Furthermore, as the output from the diesel generators decreases as the renewable electricity input increases, improved dispatch control will become essential.



## 5.0

# Renewable Electricity

### **5.1 Development**

The development of the renewable electricity programme and required investment is staged over a period of eight years, and is planned to be completed by the end of 2020. The staging provides the following advantages:

- a) Donor finance will be spread over eight years.
- b) The systems are modular and will grow in complexity with time.
- c) Local capacity will continuously grow with each project, and TEC will be able to specify, procure and manage future projects by initially supplementing and ultimately substituting overseas expertise.
- d) Local designs such as solar roofs will improve with time and experience.
- e) Technology will develop as international suppliers learn from global experience.
- f) Technology costs will continue to reduce.
- g) “Simple” and proven technologies can be installed first; more complex technologies can be installed later.

The plan must remain flexible to best meet funding and supply opportunities and should be reviewed annually. Ideally, after an initial ramp-up, the development would be spread evenly over the remaining years to allow TEC and the people of Tuvalu to adjust to the proposed work-load and to the changes in the urban environment.

A key design principle is the installation of modular technology, meaning that the systems will consist of many small building blocks that can be added over time. On this basis, the systems can grow steadily without a need for significant changes of the design.

### **5.2 Solar Energy**

In the last decade, PV technology has made huge advances in terms of improved efficiency, reduced cost and increased market acceptance, particularly in remote locations where diesel generation is the only alternative. The main benefits are the low maintenance and operation costs.



## 5.0

# Renewable Electricity

### Existing Installations

There are five PV installations in Tuvalu currently in operation or under construction:

- 40 kWp grid connected PV array on Funafuti, installed in 2008;
- 42kWp grid connected PV array on Funafuti installed in 2012
- 46 kWp PV-battery-diesel hybrid system on Vaitupu installed in 2009.
- 66 kWp grid-connected PV array associated with the new desalination plant currently under construction on Funafuti
- 9kWp standalone solar PV array associated with another desalination plant was installed in 2012.
- There are also a small number of home-based PV installations (dates unknown) on the small, most southern island of Niulakita.



*PV solar panels at the secondary school in Vaitupu, peak output 184 W/m<sup>2</sup>*

PV has been proven to perform well with the first 40 kWp grid-connected array in Funafuti, installed in 2008 and the battery-backed 46 kWp system on Vaitupu installed in 2009. Earlier small scale PV arrays installed by the Tuvalu Telecom Corporation (TTC) in 1994, have also demonstrated the durability of PV equipment.

### Capacity Factor

The capacity factor for PV arrays is defined as the actual energy produced in kWh over a year as a ratio of the theoretical capacity of the plant if it was exposed to full sunshine for 24 hours every day of the year.

The 40 kWp solar plant on Funafuti is grid-connected and all the electricity generated is supplied into the network thereby directly reducing the diesel generation required. No batteries are provided for energy storage as the maximum electricity output from the PV array injected into the network is less than 10% of the typical electricity demand. As a consequence, the diesel generator plant can absorb any fluctuations from the varying level of PV injection due to cloud movement. A capacity factor of 16.5% in 2009 and 16.2% in 2010 was calculated from the available data. The other PV array in Tuvalu, funded by Italy and Austria, has an output of 46 kWp and is located on the island of Vaitupu in 2009. This installation includes a large battery bank with a three-day storage capacity. The average annual net capacity factor in 2010 was calculated at 17.2%.

The performance of solar arrays reduces with time as the equipment ages. Typically a 15% drop-off in performance is experienced over the 25-year life of the plant. On this basis, it can be expected that the average performance in terms of electricity output over the 25 years will be about 93% of the rated output. Furthermore, as the ideal sites are used up, the remaining sites may involve some unavoidable shading that will reduce the capacity factor. On this basis, an average, long-term net capacity factor of 15% was used in the modelling of the PV systems.





# 5.0

## Renewable Electricity

### 5.3 Wind Generation

The South East Trade winds provide Tuvalu with a steady wind flow for about nine months of the year. These winds are quite reliable day and night and therefore provide an opportunity for the use of wind turbines to generate electricity that supplements PV generation that is only available during the day-time. However, the wind resource varies over the nine islands of Tuvalu with the general trend being a reduction the closer the island is to the equator.

Wind resource testing was undertaken by TEC at a point close to the power station on Fogafale in 2008 and 2009. The measurement of the wind resource was carried out at a height of 29m and the results of these tests were encouraging with a capacity factor of greater than 18%. The results of the tests are summarised in Table 5-1 below.

**Table 5-1 Evaluation of Wind in Funafuti**

Frequency and Mean Wind Speed : Funafuti 2008 -2009												
Direction	N	NNE	ENE	E	ESE	SSE	S	SSW	WSW	W	WNW	NNW
Frequency	3.3 %	5.8 %	8.5 %	13.3 %	26.3 %	27.5 %	5.5 %	1.5 %	1.2%	2.1 %	2.7%	2.4 %
Mean velocity (m/s)	4.57	4.55	4.42	4.69	6.2	7.06	5.65	3.49	3.73	5.17	6.41	

Tuvalu is located at the north-eastern fringe of the tropical cyclone zone that stretches from about 10o to 35o south and from eastern Australia to about 180o east. These cyclones tend to be more frequent in the west of this area, grow in strength and reach their peak wind velocities at about 20o south. The storms typically rotate clockwise and hit Tuvalu from the north-west. Historically, the frequency of cyclones hitting Tuvalu is about one in 25 years.

Wind generation presents a number technical challenges for Tuvalu and these are summarised below:

- a) The tropical marine environment which increases the risk of corrosion;
- b) The limited space on Fogafale due the high density of urban development and the presence of the airport;
- c) The need for specialist maintenance equipment and maintenance staff training.
- d) Occasional cyclones with wind speeds of above 180km/h.

Wind generation offers a good opportunity to supplement PV generation and to reduce both the level of battery storage required and generation from biodiesel. The optimum size ranges and configurations require careful consideration. Concerns regarding wear and tear, corrosion and maintainability need to be addressed before wind generation is introduced into the renewable electricity mix. Should investigations prove positive, these issues will be addressed during the first two years of the programme with the objective of introducing wind generation from 2015 onwards..



## 5.0

# Renewable Electricity

Figure 5.1 shows possible wind turbine locations in Funafuti.

**Figure 5-1** Potential Wind Turbine Locations- Funafuti

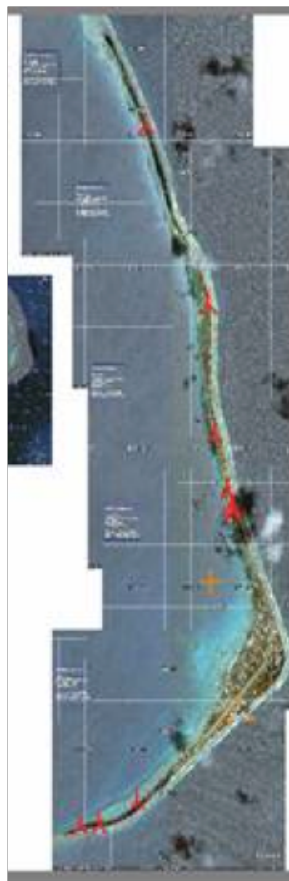

### **5.4** *Grid Stability*

The maintenance of electricity grid stability as the levels of renewable electricity injection increase will be addressed early in the programme. Renewable electricity generation is subject to relatively rapid changes in generation output. This is caused by passing clouds in the case of PV generation, and wind velocity fluctuations in the case of wind generation. Primary grid stability will be provided by the batteries. In the case of Funafuti, preliminary analysis indicates that with the existing diesel generators, it may be possible to develop 400 kWp renewable electricity generation before batteries will be required to maintain stability. Further discussion is provided in Appendix B.

### **5.5** *Demand Management*

Automatic or manual demand management will be required to balance fluctuations of power supply at times of high or low wind and sunshine or when the capacity of batteries is running low. An approach will be developed by TEC as a priority early in the programme involving remote demand management.



## 6.0

# Energy Efficiency

Improved energy efficiency is a critical component the Master Plan and along with renewable electricity, increased energy efficiency is essential if Tuvalu's energy goals are to be achieved. Reduced demand means that less expenditure is required on renewable generable plant while reduced consumption means that householders and businesses do not need to spend as much on the purchase of electricity. While this is a simple message, the implementation could be difficult. As an important step in improving energy efficiency, the Government has recently approved the implementation of labelling and standards for appliances such as freezers/refrigerators, air conditioners and lighting. This will ensure that only energy efficient appliances are sold in the local market. The programme is funded by the Australian Government and implemented by SPC. Energy efficiency improvements will be targeted on Funafuti initially. Funafuti has a higher power demand per capita and also consumes 85% of the electricity generated by TEC.

The Energy Efficiency programme, led by the Renewable Energy and Energy Efficiency Unit (REEEU) of TEC, will have a range of actions, including:

- Public education through printed media, radio and school programmes;
  - Energy audits for major consumers;
  - Trials and demonstrations on-site at TEC through the Energy Efficiency Demonstration Fair;
  - Implemented projects throughout the community; and
  - TEC advice to the general public on technology choices including the benefits of energy efficient household appliances.
- In 2012, the Cabinet endorsed the adoption by Tuvalu of the Pacific Appliance Labelling Standard (PALS Project and the Energy Department is working on the legislation to restrict the importation of non-energy efficient electrical appliances into Tuvalu.

### **6.1 Public Education**

The energy efficiency component of the Master Plan requires practical demonstrations of energy efficient technologies. In a close knit community, any successful energy saving will spread by word of mouth. In addition, TEC will communicate key messages through government, schools, via radio and monthly bills. It is one of the key tasks of the Renewable Energy and Energy Efficiency Unit to educate the public on energy efficient choices.

#### **Understanding the monthly power bill**

One of the first energy efficiency campaigns will be the improved understanding of the monthly power bill. People will be told the true cost of electricity and the level of government subsidy.

#### **Appliance Energy Use**

TEC will loan plug-in power meters to account holders so that they can monitor the energy demand of their appliances.

TEC will provide annual energy cost information on the appliances available in Tuvalu to demonstrate the annual power savings with more efficient appliances. Refrigeration appliances are the major users of electricity in Tuvalu and there is scope for significant energy efficiency improvement. Implementation of the appliance labelling programme will assist consumers to better understand appliance energy use and the cost benefit implications.





## 6.0

# Energy Efficiency

### Demonstration Fale

An important tool for the demonstration of energy efficiency will be the Show Home that TEC will install on its grounds by the end of 2013. This will be funded by the UNDP through its SIDS-DOCK fund and will become a centre of learning. People will be able to have a look at energy efficient construction elements and appliances on their way to paying their monthly bills.

The objectives of the Demonstration Fale are:

- a) To demonstrate renewable energy and energy efficiency technologies to the public of Tuvalu;
- b) To be used by the REEEU as an office and educational facility;
- c) To be used by TEC and relevant third parties for the testing of new appliances;
- d) Encourage community discussion on energy efficiency.

This building will match the local style of house design and will feature on a small scale all renewable energy and energy efficiency technologies that are to be introduced to Tuvalu. This modern Tuvaluan fale, as proposed, is a structure containing both contemporary and traditional features and is intended to demonstrate the efficient use of energy in a house.

It has the following features:

- 80 square metres enclosed floor area;
- 40 square metres open parasol structure supporting PV modules rated at 4 kWp.;
- 180km/h wind speed cyclone resistant design;
- Roof design composed of traditional thatch on modern cyclone resistant plywood;
- Air conditioned, ventilated and open rooms; and
- Raised for flood protection.





## 6.0

# Energy Efficiency

The technologies that can be demonstrated at this facility are wide ranging and could potentially include a small wind turbine, batteries, an inverter for grid connection or off-grid operation, low energy air conditioning with remote demand control, cool energy storage, refrigeration and other low energy devices, fans, energy monitors and controllers, insulation, glazing, water collection and storage, low energy lighting, biomass-based cooking, etc.

### 6.2 High User Energy Audits

#### Power demand analysis

Preliminary analysis of the electricity requirements in terms of demand and consumption of large consumers in Funafuti, such as the government building, the hospital, the refrigerated shipping containers (“reefers”) and the desalination plant, has been carried out in Funafuti. Some of the demand and consumption profiles were determined from known patterns of use but others may need some more detailed investigation (e.g. the hotel) where patterns are irregular. Table 6.1 sets out recent annual consumption figures for the top 20 electricity consumers in Tuvalu. An improved knowledge of the power demand and consumption will influence the technical specifications and the resources that need to be mobilised.

#### Energy Audits

Audits have been completed on a number of buildings and significant energy saving opportunities have been identified. The REEEU at TEC will continue to carry out energy audits of the high energy customers. These energy audits will identify opportunities to reduce energy consumption that are due to a number of different factors including out-dated technology, inadequate maintenance, wear and tear and inefficient processes or building-related issues such as; ventilation, insulation, windows, shading, etc. The REEEU will also advise on technical or operational solutions, will estimate potential power savings and advise on the acquisition of energy efficient equipment.

Energy audit guidelines have been prepared and comprise:

- Energy audit process.
- Energy audit templates.
- Customer energy use self-assessment form and guidelines.



# 6.0

## Energy Efficiency

**Table 6-1 Top 20 electricity consumers (kWh/annum)**

Customer	kWh/year
Government Building	335,280
Princess Margaret Hospital	186,840
JY Freezer	46,338
Desalination Plant	44,383
Telecom Hub	34,493
Mackenzie Reefer	33,197
TCS Freezer	31,900
Wharf	28,083
TCS Main Office	26,152
Fusi	25,875
NAFICOT	22,191
Sulani Refeer	18,799
Waste Management	18,052
Fisheries	17,407
USP Centre	16,763
Media Building	16,479
Telecom Offices	16,381
Laloniu Reefer	15,058
Pacific Energy	13,858
JY Shop	13,263

### 6.3 Technology Improvements

#### Air Conditioning

Air conditioning is estimated to contribute to 30% of the energy demand of Funafuti.

The use of air conditioning of offices is part of the modern work environment. It is estimated that about 1000 air conditioning units are installed at offices, mainly on Funafuti, to increase productivity and to reduce corrosion of electronic appliances from the salt-laden air, which is particularly aggressive in Funafuti. Public places and private homes do not typically have air conditioning and people rely on shading, natural draft or fans for cooling. Influenced by the tropical ocean currents, air temperatures vary little between 29 and 33oC during day and night throughout the seasons. An indoor temperature of 28oC with a slight draft is considered comfortable.

The air conditioning plant of the government building will be evaluated early in the energy efficiency programme as it is the largest single energy user in Tuvalu.





## 6.0

# Energy Efficiency

The system comprises 18 individual units each with separate ducting for cool air and with installed electrical rating of 10 kW. Detailed investigations and improvements will be trialled on individual units. Improvements of the air conditioning could include:

- a) Use of auxiliary fans;
- b) Improved temperature controls;
- c) Elimination of plant design flaws (e.g. cooling process, shading, ventilation);
- d) Improvements in the building envelope (e.g. air leakage, insulation, shading, natural cooling);
- e) Review of cooling technology (e.g. more efficient plant and equipment);
- f) Energy buffering; and
- g) Repairs and maintenance.

### Refrigeration

Refrigeration is estimated to use about 30% of the generated energy and has two key technologies:

- a) Freezers for long-term food storage, (eg. containers at the port, commercial shop freezers and residential freezers); and
- b) Refrigerators for short-term food storage and display.

While these technologies are similar in principle, the difference is in the operating temperatures, the technology used and the operation of the appliances. TEC's REEU will investigate typical industrial, commercial and residential applications and identify the best-value-for-money improvements of these appliances. As with air conditioning, initially the users may adjust some settings or ways of operation. The next step will involve a review of the technology used.



*Freezer Boxed Design*



## 6.0

# Energy Efficiency

### International Collaboration

The REEEU will network with regional and international organisations on renewable energy and energy efficiency.

### Lighting

Energy efficient compact fluorescent lamps (CFL) (energy efficient light bulbs) are widely used in Tuvalu. In 2011, TEC installed trial LED street lighting and is likely to install additional LED lighting in 2012 and 2013.

### Energy Buffering with Ice

A major recurring capital expenditure in the renewable energy management will be batteries. In the course of the 10-year programme, more batteries will be required as the use of diesel generation is reduced. As batteries are (still) very expensive to purchase and to recycle, alternatives will be investigated. One possibility is the use of ice as an energy buffer.

This principle is adopted in the air conditioning of government and commercial buildings in other parts of the world where, for example, the overnight electricity tariff is much lower than the daytime tariff. In such installations, ice is generated in purpose designed tanks overnight and “burnt” during the day when cooling is required. While this tariff situation does not exist in Tuvalu, any surplus PV generation could be used by chillers to produce ice for storage until required. The central air conditioning units of the Government building are 10 years old and require continuous maintenance. When replacement is considered necessary, an ice tank system could be evaluated as an option.



*Government Building in Funafuti*

### 6.4 Demand Side Management

Procurement and instalment of pre-payment smart meters to all electricity users is a priority. TEC currently has slightly over 2000 customers connected and, as well as improving the efficiency of revenue collection, the meters will enable implementation of a differentiated tariff that varies the tariff to match the generation and demand profile, making it possible to shift the demand profile according to availability of supply.



# 7.0

## Energy Economics in Tuvalu

### 7.1 Diesel

The cost of diesel fuel used by TEC for electricity generation was recorded from 2006 to 2010. The figures for 2004 and 2005 were provided by Kansai Electricity in the feasibility study for the E8-funded 40 kWp PV solar system in Funafuti. Up to 2010, the Japanese government subsidised the cost of the diesel fuel but in 2011, this policy was changed and diesel fuel was donated to directly to TEC. Therefore, the 2011 figure was extrapolated from data by the Australian Petroleum Institute for the Australian wholesale market with an addition of about A\$0.30 for the additional transport cost between these countries. The trend line has an increase of 10.7% annually, which is the nominal average annual diesel price increase in Tuvalu over the past seven years (Figure 7.1 refers). To provide a comparison, Figure 7.2 shows the long-term trends in US\$ for Brent crude.

Figure 7-1 Diesel price trend

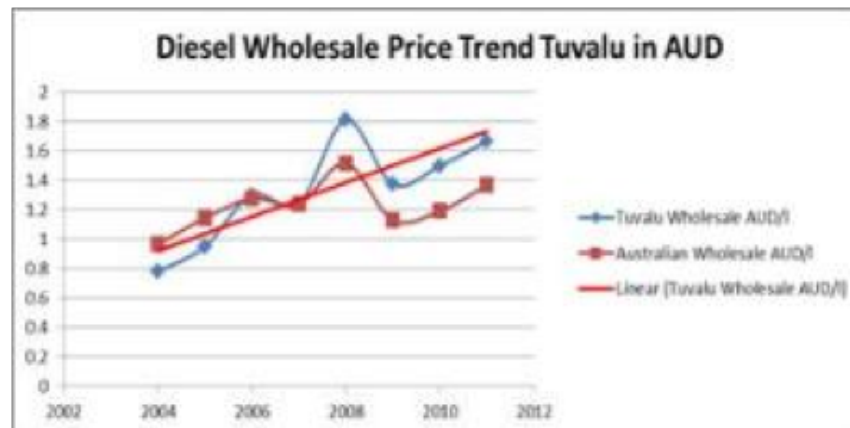

Figure 7-2 Historic Brent crude oil price



Source: <http://www.oilenergy.com/1obrent.htm>





## 7.0

# Energy Economics in Tuvalu

On this basis, it was assumed that the inflation-adjusted, average oil price increase of 5% per annum would be conservative and is used in the economic modelling of the renewable electricity value in Tuvalu, starting with a baseline of A\$1.50 per litre in 2010.

### 7.2 Solar Generation

Tuvalu is a tiny market in a remote location with little resources. These conditions impact on the cost of equipment supply in Tuvalu, including PV systems. It was therefore considered prudent to use TEC's own experience with the 46 kWp Vaitupu system for the initial estimation of costs. The total installed cost of the Vaitupu system was calculated at A\$14,500/kWp in 2011; costs included batteries, a support frame, design and project management.

There are a number of factors that will affect the installed costs of future PV systems in comparison with the above benchmark. Some of these are expected to reduce future costs such as a continuing trend downwards in the cost of PV modules and the larger project scale. On the other hand, factors likely to increase the cost include costs associated with maintaining grid stability and building upgrade work associated with the 1000 roof programme.

In light of all the above, an average installed cost of PV in Tuvalu of A\$12,500/kWp in 2011 costs has been used in the economic analysis. A breakdown is provided in Appendix A. Future project experience will provide better data and will be considered as part of a continuous review of this Master Plan.



*Battery Bank in Vaitupu*

### 7.3 Wind Generation

Based on information from wind turbine suppliers, it is estimated that the installed cost of units likely to be most suitable for application in Tuvalu will range from A\$4,000/kWp to \$10,500/kWp for 275 kW to 6 kWp respectively including design, project management and connection to the grid. Turbines within this range suitable for application in the Pacific Island environment are available, including provision to enable lowering in the event of an incoming cyclone. Table 7.1 shows indicative costs:



# 7.0

## Energy Economics in Tuvalu

**Table 7-1 Wind turbine indicative costs**

PEAK OUTPUT KW	6	50	275
Turbine including tilting mast	\$50,000	\$230,000	\$640,000
Installation including transport, foundations, erection, commissioning and training	\$8,000	\$130,000	\$250,000
Spares	\$5,500	\$15,000	\$42,000
<b>TOTAL</b>	<b>\$63,500</b>	<b>\$375,000</b>	<b>\$932,000</b>
Cost per kW installed	\$10,583	\$7,500	\$3,389

A combination of wind and PV generation will provide benefits in reducing battery storage or reduced diesel generation. In the case of Funafuti, based on wind patterns, solar radiation data and the daily power profile, a preliminary evaluation indicates that the optimum energy mix will be 2/3 PV solar and 1/3 wind energy. This optimum would reduce required battery storage by up to 30% and minimise standby biofuel generation. Furthermore, this will also assist in resolving the issue of limited space for PV arrays in Funafuti.

Further investigation is required to confirm the feasibility of wind generation but given the potential benefits in terms of cost of generation, it is considered that this will be a worthwhile investment. The investigation will confirm the earlier wind data collected and will examine the technical and environmental issues that require resolution if a turbine of 275 kWp is to be installed, noting that this would bring significant cost advantages. In view of the uncertainties that will have to be resolved before the wind option is finalised, all cost analysis assumes that PV only will be used.

### 7.4 Bio-Diesel

Introduction of bio-diesel is the last stage of the master plan and has not been included in the economic analysis. When 85 to 95% of energy demand is generated from renewable energy sources it is calculated that the required bio-diesel volume will be in the order of 100,000 litres. The small volume is likely to be uneconomic to produce on Tuvalu and it is assumed that bio-diesel will be imported. The cost difference between bio-diesel and diesel has minimal impact on the economic analysis.

### 7.5 Energy Efficiency

Energy efficiency is an important component of the Master Plan. International experience has shown that in terms of cost benefit, expenditure on energy efficiency measures provides superior return on investment than providing the generation capacity that would otherwise be necessary. An ambitious target for improvement in energy efficiency has been set at a 30% reduction in terms of electricity consumption per notional GDP and on this basis, the modelling of the future renewable energy requirement is based on the assumption that the economy would grow by about 2.5% per year (net). A 30% reduction of energy demand per GDP on Funafuti will be equivalent to a 25% reduction of energy demand per national GDP up to 2020 and on this basis, the overall electricity demand will remain steady at the 2010 level until 2020.



## 7.0

# Energy Economics in Tuvalu

Energy efficiency improvements will be initially targeted on Funafuti. Funafuti has a higher power demand per capita than the Outer Islands and also consumes 85% of the electricity generated. However, as TEC staff gain experience in energy efficiency implementation, the Outer Islands will be incorporated into the energy efficiency programme.

In the financial model, capital for the purchase of energy efficient equipment was not included on the grounds that overall the economic benefits will outweigh the initial costs. Early in the implementation of this Master Plan, options to encourage replacement of energy-inefficient equipment with energy efficient equipment will be considered and incorporated into the energy efficiency programme.

### **7.6 Economic Analysis**

Currently Tuvalu imports 1.76 million litres per year of diesel fuel at a cost of A\$1.50/litre. Conversion to renewable energy will reduce the diesel demand. The objective of this Master Plan is that by 2020, diesel generation will be reduced to between 5% and 15% of current generation. The cost of solar arrays and batteries to replace the current energy demand is estimated to be A\$52 million. Savings in diesel fuel over the life of the project are estimated to be A\$150 million.

Even after implementation of the renewable electricity programme and including energy efficiency improvements, some diesel generation will be required to provide stand-by generation when prolonged weather conditions limit renewable electricity production. On the basis of the existing diesel generators being maintained for stand-by use until converted to bio-diesel operation, the cost benefit of the renewable electricity programme is mainly determined by the following three factors:

- a) The project life;
- b) The marginal cost of power generation from diesel during the project life; and
- c) The cost of the renewable energy equipment and maintenance spread over the project life.

### **Cash Flow Analysis**

Cash flow analysis is a common and simplified method of establishing the cost benefit of an investment by taking into account the initial capital investment, other costs incurred during the life of the project (such as operating and maintenance costs) and the identified cost savings that result as a consequence of the project. The following cash flow analysis is based on the following assumptions:

- a) The solar arrays have a 30-year life. PV modules are typically guaranteed for 25 years. However, the technical life can be expected to be slightly higher, e.g. 30 years;
- b) Energy consumption remains at 2012 levels for the first eight years through the energy efficiency programme, following this period energy use increases at 2% matching GDP;
- c) 5% per year ongoing, real price increase of diesel;
- d) All costs are based on 2011 values;
- e) Battery capacity will provide two days' energy consumption on Funafuti and three days' energy consumption on the Outer Islands;





# 7.0

## Energy Economics in Tuvalu

- f) Batteries are replaced every 5 to 10 years, it is expected that good quality inverters will last 15 years.
- g) Operations & maintenance cost are conservatively assessed as 2% of the new (2011) asset value;
- h) Disposal cost not included in calculation (due to timing);
- i) Renewable energy investment paid by donors during first 10 years; and
- j) TEC pay all operations and maintenance costs plus replacement cost (mainly batteries).

The annual cash flow is expected to be as shown in Figure 7-3:

**Figure 7-3 RE and Diesel Annual Cash Flow**

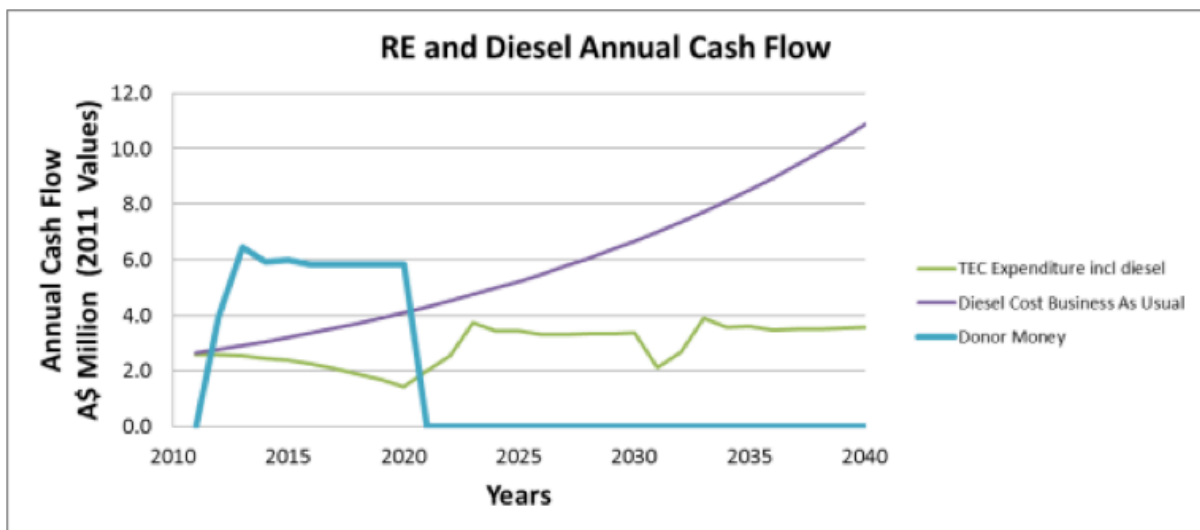

The above figure compares annual expenditure on generation assuming implementation of the renewable electricity programme, with that of continuing to generate using diesel generation as at present. The renewable electricity expenditure includes operations & maintenance, diesel/bio-diesel costs and future equipment replacements (eg. batteries and inverters). It is estimated that the renewable electricity generation costs will remain at a similar level to the current diesel costs and much lower than the predicted diesel costs, with the gap increasing with time as diesel fuel prices increase.

The figure also shows the required donor investment of A\$6.5 million per year for the next eight years that will allow the renewable energy programme to be completed by 2020. This is based on the programme commencing in 2012.



# 7.0

## Energy Economics in Tuvalu

The following graph shows the accumulated cash flows.

**Figure 7-4 Renewable Energy and Diesel Accumulated Cash Flows**

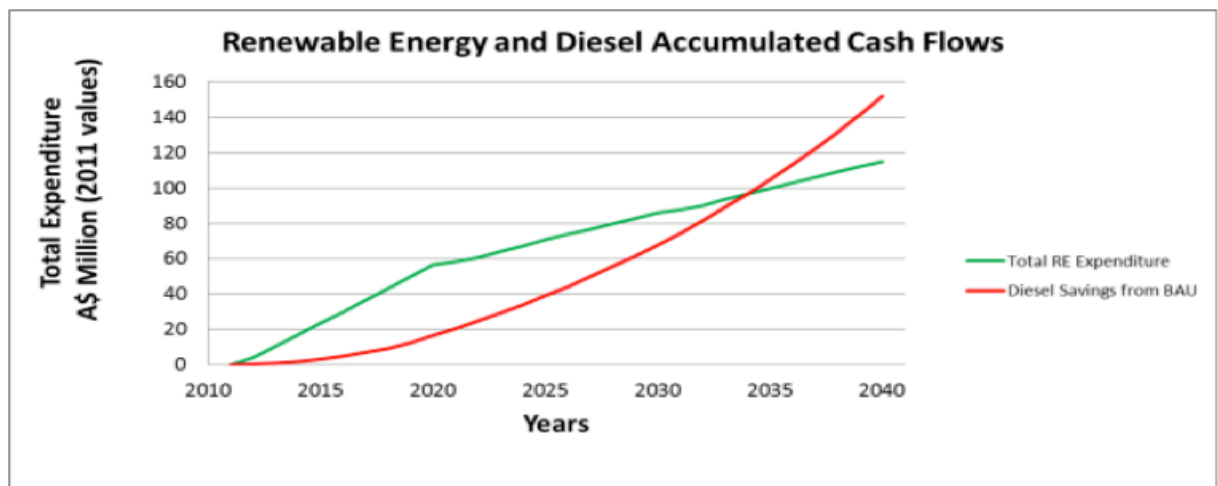

Key points to note are:

- a) Diesel expenditure, business as usual (BAU) accumulating to A\$176 million in 30 years;
- b) Total renewable electricity expenditure including replacement capital and operating costs accumulating to A\$115 million; and
- c) If all renewable energy expenditure were compared with diesel savings, the payback would be 20 years.

### Discounted Cash Flow Analysis

Project economics are often analysed with the help of models calculating net present values (NPV) or internal rates of return (IRR). Net present values discount future costs and income streams with certain discount rates based on risk and weighted average costs of capital.

A discounted cash flow analysis was completed using the simplification that the full conversion to renewable energy occurs in the first year to show a clear comparison between renewable energy and the existing diesel generation. The analysis considered the installation and battery replacement costs, cost of diesel fuel and additional operations and maintenance costs for the renewable energy plant. All other costs (eg. cost of maintenance and replacement of diesel generators) were considered to be the same in both the business as usual and renewable electricity options and were not specifically included in the analysis.

Based on the above, and a 5% discount rate and 3% inflation, the net present value was found to be A\$20 million with a payback period of 18 years and an internal rate of return of 7%. While showing a net benefit, this analysis indicates that the rate of return is less than that would normally be considered attractive by a private sector investor.



# 7.0

## Energy Economics in Tuvalu

A sensitivity analysis on the key parameters found the following results.

Cost of installation	Average annual increase in diesel	Discount Rate	Net Present Value	Payback Period	Internal Rate of Return
A\$52 Million	5%	5%	A\$20 Million	18	7.0%
A\$62 Million	5%	5%	A\$2 Million	22	5.2%
A\$52 Million	2%	5%	(A\$ -22 Million)	27	1.7%
A\$52 Million	8%	5%	A\$93 Million	15	11.2%
A\$52 Million	5%	8%	(A\$-7 Million)	18	7.0%





## 8.0

# Implementation Strategy

### **8.1 Funding**

Funding this programme as one package rather than as a series of individual projects will provide Tuvalu with a steady funding stream and a long-term commitment by donors for the implementation of the investment plan. The funding can be arranged as co-funding amongst a group of nations. The estimated finance is A\$6.5 million per year from 2013 to 2020. A technical assistance package will be required to assist TEC with implementation while ongoing maintenance and replacement capital (mainly batteries and electronic controls) will be funded by TEC from revenue.

The infrastructure is designed for 30 years and will need to be replaced in stages after 2040. By that time, fossil fuels are assumed to be four times as expensive as in 2010 and renewable energy will be the only affordable alternative for Tuvalu.

### **8.2 Capacity Building**

As the government enterprise responsible for generating and distributing electricity, TEC is at the centre of the renewable electricity and energy efficiency programme. Therefore, the capacity building of TEC staff is critical to programme success. In the past, worthwhile projects have often not been successful because of the lack of capacity building that included practical elements, including for example, equipment trial periods that provided operating and maintenance staff with “hands-on” experience in day to day operations and trouble-shooting. Technologies and equipment will need to be carefully selected to enable construction, operation and maintenance by Tuvaluans given the relative remoteness of Tuvalu and the time and cost involved in procuring overseas maintenance personnel. However, as a consequence of this remoteness, Tuvaluans have developed a good level of practical skills and, with appropriate training, TEC will be capable of carrying out most of the maintenance required.

While external specialist technical assistance will be required, maximising the involvement of TEC in the programme from procurement to commissioning will not only provide employment opportunities for local people, but will also reduce costs compared with employing expatriate staff by an estimated 20%.

#### **Tuvalu Electricity Corporation**

The proposed construction programme, with an annual budget of approximately A\$6.5 million, will have a large impact on TEC’s business. In order for TEC to manage the capital investment programme, TEC will need to develop further capacity in the following areas:

- a) System evaluation and design;
- b) Project management;
- c) International procurement;
- d) Project administration;
- e) Construction management;
- f) Electronic controls; and
- g) Marketing (for community support)



## 8.0

# Implementation Strategy

The REEEU is part of TEC, and the expatriate REEE Manager reports to the General Manager of TEC. A full-time, local supervisor is allocated to the REEEU and has received training for the ongoing management of the programme. During the roll-out of the programme, the unit will need to increase their staff to five to 10 people for project management, administration, and promotion within the community.

As outlined in the previous section, the capacity building programme will include TEC staff and other stakeholders receiving practical training in the installation and operation of renewable energy equipment. This will provide TEC and the people of Tuvalu with the confidence to select suitable and sustainable technologies in the future.

It is anticipated that the design and construction of the various projects will initially be executed by suppliers or external contractors. The main tasks for the REEE Manager and Supervisor will include liaison with stakeholders, suppliers, contractors and donors. As sufficient experience is gained, TEC will increase the level of involvement of TEC staff and thereby reduce the costs.

The integration of the renewable electricity generators will also involve the TEC Generation and Distribution Managers and their staff. Some of the TEC staff may require overseas training.

Eventually, in the course of the 10-year development programme, TEC's focus will shift from diesel-powered electricity generation to renewable energy, and staff resources will adjust to the new focus. TEC's future Business Plans will incorporate relevant aspects of this Master Plan.

### **8.3 Policy and Regulations**

In order to facilitate a smooth implementation, whole-of-government support is required for the setting of policy, legislation, rules and regulations. The following is a list of possible examples only and thus not complete; these rules and regulations will be introduced over time and in accordance with priorities:

#### **Land and Ownership**

- The Government will legislate as necessary to obtain community co-operation with TEC on the installation and maintenance of energy equipment such as solar modules, inverters and power meters.
- New businesses or developments will be required to install solar modules on their roofs (e.g. the planned airport terminal).
- TEC will own and operate all grid-connected power generation systems including the roof mounted arrays.
- TEC will obtain a written agreement by the property owners before renewable energy generation equipment is installed. This agreement will include the financial arrangements for any intended roof modifications and provide for access to install and maintain the equipment.



## 8.0

# Implementation Strategy

- Public or private property owners will take all due care to ensure power generation equipment is not damaged and will perform satisfactorily. Property owners will follow TEC's advice on matters like tree cutting and provide TEC with the required access for such maintenance.
- Private people have the right to own and operate power generation equipment that is not connected to the grid and that is safely installed and operated. The safety and performance of such equipment is the responsibility of the owner.

### Commercial Relationships

- TEC's industry structure, e.g. TEC working as a corporate body with international accounting practices.
- TEC will inform the public on efficient and safe energy utilisation.
- TEC is allowed to trade in the supply of electrical appliances and equipment for the purpose of promoting the safe and efficient use of electricity. This is not a monopoly for TEC and private sector companies are also permitted to participate in this market.
- Electricity tariffs will be reviewed on a regular basis to support the development of a renewable electricity based infrastructure and assist with energy efficiency.
- TEC may subsidise the procurement and installation of energy efficient equipment or private installation of renewable energy equipment, where this is economic for TEC as a state-owned electricity supplier. This will be decided on a case-by-case basis, using criteria agreed between TEC and the Government of Tuvalu.

### Technical Standards

- TEC will identify technical standards relevant to Tuvalu's Renewable Electricity & Energy Efficient Master Plan and will make these standards available for public viewing.
- The Government of Tuvalu will appoint authority to appropriate organisations to ensure the proper implementation of technical standards, such as the cyclone proofing of buildings and roofs.

### Environmental

- TEC will inform and consult with the community on environmental impacts of the renewable energy. In cases of dispute, the Government of Tuvalu will mediate.
- The Government will prepare special regulations covering certain principles, such as roof-mounting of solar panels instead of ground-mounting.
- The implementation of this Master Plan has a high priority and it will be important to ensure that community groups and other stakeholders participate in environmental debates in a timely manner.

### Social

- The Government of Tuvalu and TEC have an obligation to implement the Master Plan in the most economical way. Both parties will consider local employment, where this is feasible, to stimulate the local economy.





## 8.0

# Implementation Strategy

- The electricity system design will consider demand side management at times of energy shortages. In such cases, social needs of the community will be considered and priorities set. In the case of dispute, the Government of Tuvalu will make the ultimate decision.

### **Cultural**

- TEC will take into account the cultural heritage of Tuvalu. For example, traditional house designs will be supported where feasible.
- Cultural heritage will also be considered in the utilisation of energy such as in the use of land, design of house and food preparation.
- In its promotions for Energy Efficiency and for “Enetise Tutumau” (steadfast electricity), TEC and the Government of Tuvalu will use the Tuvaluan language, where possible.



# References

***The following documents were referred to in the preparation of the Master Plan:***

E8 (2009) *The Tuvalu Solar Project*. E8 General Secretariat, Montreal, Canada.

Ecology Management ApS (2010) *Tuvalu Wind Power Development: Wind Study and Feasibility Report*. Report prepared for the Secretariat of the Pacific Regional Environment Programme (“SPREP”) Apia, Samoa.

Empower Consultants (2008) *Tuvalu Electricity Corporation: Loss Reduction Programme*. Stage 1 Report. For the Ministry of Economic Development. Empower Consultants Ltd, Wellington.

Empower Consultants (2009) *Tuvalu Electricity Corporation: Loss Reduction Programme*. Stage 2 Report. For the Ministry of Economic Development. Empower Consultants Ltd, Wellington.

GL Garrad Hassan (2012) *Funafuti Wind Energy*. Report for the MFAT Pacific Energy Programme. Garrad Hassan Pacific Pty Ltd, Wellington

Government of Tuvalu (2005) *Te Kageega II: National Strategies for Sustainable Development 2005-2015*. Economic Research and Policy Division, Ministry of Finance, Economic Planning and Industry, Funafuti.

Government of Tuvalu (2009) *The Kakeega II Matrix: Year Four*. Economic Research and Policy Division, Ministry of Finance, Economic Planning and Industry, Funafuti.

IT Power (2013) *Grid Connected Solar PV: Tuvalu*. Report for the MFAT Pacific Energy Programme. IT Power (Australia) Pty Ltd. Turner ACT.

IT Power (2013) *Nanumanga Mini Grid PV: Tuvalu*. Report for the MFAT Pacific Energy Programme. IT Power (Australia) Pty Ltd. Turner ACT.

IT Power (2013) *Nanumea Mini Grid PV: Tuvalu*. Report for the MFAT Pacific Energy Programme. IT Power (Australia) Pty Ltd. Turner ACT.



# References

IT Power (2013) *Niutao Mini Grid PV: Tuvalu*. Report for the MFAT Pacific Energy Programme. IT Power (Australia) Pty Ltd. Turner ACT.

KEMA (2013) *Funafuti Atoll, Tuvalu Distributed Renewable Generation Study: Integrating PV Solar and Wind generation with the TEC electric system*. Report for the MFAT Pacific Energy Programme. DNV KEMA.

Opus (2013) *Economic Assessment of Renewable Energy Generation for Tuvalu*. Report for the MFAT Pacific Energy Programme. Opus International Consultants Ltd. Wellington.

Ridgway (2008) *Study into the Establishment of a Renewable Energy & Energy Efficiency Unit at the Tuvalu Electricity Corporation: Final Report for SPREP – Pacific Regional Environment Programme*. Ridgway Capital Projects Limited. Christchurch.





## Appendix A

# Solar Energy Concepts



## Appendix A

# Solar Energy Concepts

### System Concepts – Outer Islands

The renewable electricity generation and distribution systems proposed are as follows:

a) **For seven Outer Islands:** small island grids working on 230/400 VAC with peak demands between 30 and 100 kW, with renewable electricity provided by PV with batteries and a diesel generator. Wind generation may be added at a later stage. A standard mini-grid design based on a model design developed for MFAT will be considered for adoption. It is anticipated that the management and control of the systems will be similar to that proven in service in Vaitupu.

b) **For Niulakita:** home-based PV and battery systems on low voltage DC.

### Funafuti – Decentralised Solar Roof Concept

Funafuti has a population of in excess of 5000 with about 900 dwellings and about 250 government and commercial buildings. Fogafale is the main island of the Funafuti atoll on which nearly 100% of the population live. Fogafale is densely populated with little spare land.



Long stretches of the island are very narrow with just sufficient space for a house and the road. In the east is the deep ocean, on the west the shallow lagoon. In the central part of the island, a large area is occupied by the airport runway.



## Appendix A

# Solar Energy Concepts



With Funafuti having reached a very high population density, land has become a scarce resource. Unoccupied land has to be regarded as a reserve for future buildings or high quality land use. For this reason, ground-mounted solar arrays are considered environmentally and politically unacceptable and why TEC has been promoting a 1000 Solar Roof concept.

The Tuvalu “Solar Roofs” concept will have the following features:

- a) Solar roofs will be clear of shading;
- b) Solar roofs will be designed for technical lives of more than 30 years;
- c) Solar roofs will be cyclone-proof, water-tight, rainwater-collecting, non-corrosive and low maintenance;
- d) Solar modules will to be removable for quick maintenance;
- e) Electrical connections will to be accessible, durable and safe;
- f) Solar roofs will need to have spare space for access and geometric / structural reasons (estimated 20%);
- g) The modules will need to have clearance for natural ventilation to avoid overheating and;
- h) The roofs have ideally a pitch between five and 10 degrees and face northwards. However roofs that are not shaded, but are of low pitch or orientated other than to north, will be considered for approval by approved by TEC.





## Appendix A

# Solar Energy Concepts

### Key Issues

A key assumption is that as critical infrastructure the electricity generation and network should survive or be repairable within a reasonable time following a major cyclone, including resistance to wind pressures and flying debris and storm surge. With this in mind, a detailed survey has been undertaken of the building stock in Funafuti taking into account the following factors:

Mounting of Photovoltaic panels:

- Competition for use of ground space, shading factors and vulnerability make widespread use of ground-mounted panels impractical, particularly on Funafuti.
- Potential of mounting on the roofs of substantial buildings is good but roof strengthening and repair will need to be considered and engineered.
- The replacement of very light parasol additions to domestic houses would initially be the best domestic solution as the durability of the base structure can be engineered, made standard and maintained. A prototype should be engineered and built to advance this concept.
- Domestic roofs are varied and support structures often in poor condition. Even new housing will require proof of structural engineering to support the panels.
- The economics of building have led people into higher maintenance and shorter life solutions which limits the durability of domestic rooftop solutions.
- The unratified Tuvaluan standard set the design wind speed as 45 m/s and has no recommendation with respect to storm surge. In our view, the design wind speed for infrastructure should be set against a maximum likely event based on current trends within the next 50 years. Cyclone Bebe would seem to represent this. In order to make a decision, the data on either the recorded 1 minute wind speed or the best official estimate needs to be obtained, as well as storm surge pattern and effects. Analysis should then be made of other possible directional scenarios using an accepted methodology.



*TEC staff installing a non-metallic, low maintenance and cyclone proof demonstration solar roof*



## Appendix A

# Solar Energy Concepts

### Building Surveys

A general survey was taken of buildings and houses throughout Fogafale and a report provided to TEC. Special attention was given to the PWD Standard for Houses and Public Buildings such as the Princess Margaret Hospital. A meeting was also held with the Deputy Director of Health with respect to the hospital. Measurements were taken and the structure noted. At various times informal meetings took place with relevant individuals.

The report sets out the results of the survey including the condition of the buildings and the ability of the building structures to support the solar arrays and withstand cyclone conditions. Details of the strengthening work recommended are included in the report.

### Batteries

Batteries will be required for grid stability reasons and for daily energy buffering. Initially, the diesel generators will fulfil this role, but as the level of renewable electricity generation injection increases, batteries will be required. Preliminary grid stability modelling has indicated that batteries will be required once the installed capacity of the renewable generation reached about 400 kWp. This is expected to occur in 2014.

In the Outer Islands, the operational battery capacity will be based on three days of average daily energy consumption to provide an acceptable level of supply security.

For Funafuti, the initial battery capacity will be provided to ensure grid stability only and renewable electricity shortages owing to weather conditions will be compensated with diesel-generated power. By 2020, it is proposed that that Funafuti will have two days of battery capacity in order to provide additional capability to cope with adverse weather conditions and minimise diesel/biodiesel generation. Some care will be required in the selection and arrangement of inverter equipment to ensure that compatibility with a future grid management system – particularly as the level of battery storage increases.

### Required Renewable Energy Capacity

Table A-1 over sets out estimates of the renewable electricity capacities required.

Relevant factors taken into account were:

- a) The net average capacity factor of 15.0% was derived from the Vaitupu plant (17.2%) and the Funafuti plant (16.2%) and then allowed for reduced PV array output with time. It is noted that the Vaitupu plant has performed better, particularly considering that this included battery losses, which the Funafuti plant does not have because it is grid-tie system.
- b) The generation target on Funafuti is based on 95% of the current value, assuming that consumption will not increase due to energy efficiency balancing new load expected from GDP growth. The generation target for the Outer Islands is assumed to be 130% of current demand due to economic development that is partly a result of the increased availability of electricity. For the purposes of the estimates, no allowance is made for improved energy efficiency although this is expected to show some results with two or three years.
- c) Net battery losses were assumed to be 7%.



## Appendix A

# Solar Energy Concepts

### Cost Estimates

Table A-2 over shows the basis for the figure of \$A12,500 per kWp used in the cost analysis cost.

**Table A-1 Estimates of required renewable electricity capacity**

Atoll/Island	- Population - Customers - Av h/h size	Annual consumption per capita(kWh)	Peak demand kW	Estimated kWp for maximum RE <sup>1</sup>
Funafuti	- 5,277 - 870 - 6	956	1,000	4,900
Nanumea	- 773 - 147 - 5.3	143	37	74
Nanumaga3	- 685 - 142 - 4.8	168	37	77
Niutao3	- 772 - 175 - 4.4	142	39	74
Nui3	- 638 - 138 - 4.6	188	31	81
Vaitupu	- 1,851 - 288 - 6.4	159	95	197
Nukufetau3	- 682 - 147 - 4.6	176	38	81
Nukulaelae3	- 457 - 90 - 5.1	153	20	47
Niulakita	- 41			
<b>TOTALS</b>	<b>11,126</b>		<b>1,297</b>	<b>3,986</b>

**Notes:**

- (1) RE = renewable electricity generation (PV and/or wind)
- (2) Energy efficiency improvements assumed for Funafuti but not for Outer Islands.
- (3) Data includes some estimates.





# Appendix A

## Solar Energy Concepts

**Table A-2 Basis for cost estimate for renewable electricity generation plant**

PV solar based on Tūvalu Vaitupu Experience	2009 at 2011	economise at 2011
	AUD/kW	AUD/kW
Design and Project Management	1,32	1,00
Support Frame / Solar PV Array and electrical Inverter	3,92	2,50
Cabling and Switches	1,04	1,04
Batteries, Battery Controller	3,37	2,69
Spare parts	63	63
Freight	38	38
Installation and Commissioning	75	75
<b>Tota</b>	<b>14,56</b>	<b>12,45</b>

### Funafuti Daily Energy Analysis

To quantify the optimum renewable energy generation mix and battery capacity, a “typical” week was modelled with regard to solar, wind and diesel power generation, demand, and the state of charge of the battery.

The modelling resulted in an economic optimum at a mix of 1/3 nominal wind power capacity and 2/3 PV solar capacity, with two-day-demand battery capacity and a generator cut-in point at 50% of battery charge. This is a design issue that will need to be modelled in more detail. For the purpose of this plan, it is important to consider that wind power can reduce the overall battery capacity and the amount of bio-diesel being used. For example, with the inclusion of wind power, bio-diesel could be as low as 5% of annual energy generation; without wind power, bio-diesel would need to be 15%. The demand for bio-diesel would also increase with reduced battery capacity.



## Appendix B

# Grid Issues



## Appendix B

### Grid Issues

#### Grid Stability

An important part of the programme implementation will be the integration of the renewable generation plant into the Funafuti network in a way that maintains grid stability. Renewable energy generation is subject to relatively rapid changes in generation conditions including passing clouds and changes in wind velocity. As the percentage of renewable energy generation increases, measures will be necessary to maintain a stable grid in terms of frequency and voltage, the most common method being the installation of batteries. Preliminary modelling indicates that on Funafuti it should be possible to develop 400kWp distributed renewable energy generation before batteries will be required. In the case of the Outer Islands, the solar-battery-diesel hybrid systems proposed are inherently stable if properly designed.

Grid stability has been modelled using Electromagnetic Transients Programme (EMTP) analysis for the integration of renewable energy generation into the existing Funafuti grid, as described in section 6.8. The grid, comprising 11kV & 415V feeders and 11kV/415V transformers, are modelled together with the three 600kW synchronous generators at the Fogafale power station. The model predicts the dynamic response of the generating plant to fluctuations in load and de-centralised renewable generation. Both peak-load and low-load conditions are separately modelled as consolidated 415V loads on each of the 14 feeders, based on the energy usage data provided.

The PV generation was modelled for each year between 2011 (all installed PV generation to date) and 2020, according to the proposed implementation programme set out in section 6.1. Diode bridge rectifier and PWM inverter components were included at the end of each LV feeder. Two disturbance scenarios were considered: a fault on one of the feeders with automatic disconnection of the transformer by the protection system; and a large cloud moving west to east (or vice versa) at 20km/hr (worst non-fault scenario), which will reduce PV output from 100% to 25% as the cloud moves over that section of the island. The 2km maximum geographic distribution of generation in the west-east direction, will translate to a 75% reduction in total PV generation within six minutes.

An important consideration in the stability study is the geographical distribution of the PV installations. If all connected onto one feeder, the cloud scenario described above will cause an instantaneous reduction in PV generation, whereas a wider geographic distribution of PV generation will cause a staged reduction in total PV generation over the six-minute interval, allowing the diesel generators to respond to the change in load on the grid without losing grid stability.

The transformer LV terminal voltage and grid frequency were monitored during the simulations. These are required to be maintained within -20% to +15% (voltage) and +2% and -5% (frequency) and were used as the criteria for acceptable grid performance.

The simulation results for the initial PV implementation stages, with no storage batteries installed, indicate that up to 400kWp of PV generation can be grid connected while maintaining grid stability during short-term disturbances if the PV generation is geographically distributed. However, if the PV generation is all located in one geographical location, the maximum that can be connected to the grid will be 200kWp.

When the above renewable electricity penetration limits are exceeded, storage batteries will be needed to ensure grid stability. It is proposed that this be initially achieved with an initial a battery installation at the power station followed by battery installations at each 11kV/415V transformer as required and in accordance with the level of PV generation installed on the associated feeder.





## Appendix B

### Grid Issues

The sizing of the batteries will be determined by the required back-up capacity rather than the transient stability requirements, which only requires power over a short duration (tens of seconds). The location of the installed batteries will be determined during detailed design in accordance with the location and capacity of the planned PV installations. It is proposed that the frequency reference for the grid be transferred from the diesel generator to the main battery inverter at the power station when installed. The generators will then synchronise to the inverter reference when required. This is most suitable for the final system, with only 5% bio-diesel generation and possibly no biodiesel generation at times. Control measures, including load dispatching, are therefore required to ensure the main batteries do not discharge beyond a minimum level required for a black-start.



*Battery Controls in Vaitupu (SMA)*

#### **Funafuti – Network Concept**

The main features of the Funafuti network are as follows:

- a) Peak demand 1,000 kW.
- b) A central 11 kV medium voltage (MV) system forming the backbone of the Fogafale grid.
- c) 3 x 600 kW central diesel generators feeding into the 11 kV grid, one or two on standby depending on demand (900 kW day, 500 kW night).
- d) 14 step-down transformers associated with 14 independent low voltage (LV) 230/400 VAC networks.



## Appendix B

### Grid Issues

The implementation of the proposed renewable electricity system will be as follows:

- a) As a matter of principle, decentralised, roof mounted PV arrays, with inverters being coupled with the 230V AC systems, will be installed on government / industrial / commercial roofs first, followed by residential roofs.
- b) In Phase 1, grid-connected solar arrays can be added without causing grid instability up to a total output capacity of about 400 kWp (assuming the PV generation is evenly spread geographically). As each new section of renewable generation is commissioned, grid stability will need to be monitored. If a large percentage of the renewable generation is to be concentrated in one area, batteries may be required to buffer fluctuations.
- c) As the level of renewable generation approaches the point where instability is likely, batteries will need to be installed both centrally (initially) and de-centrally to buffer fluctuations in renewable generation.
- d) Ultimately, it is proposed that each LV network will have a battery bank adjacent to the transformer being charged by the associated PV arrays connected to that network and, when required, from other sources via the central 11 kV network. The battery switching will be controlled by control boxes (shown as CB on the schematic that follows) to either be charged by the 230 VAC system with PV electricity (daytime) or to discharge to the LV grids via a suitable inverter system. On most sunny days, the batteries will be charged from the decentralised PV systems during the daytime and “topped up” by the diesel generator at night.
- e) There will be a central large battery bank next to the generator for balancing the different states of charge of the local batteries and buffering large short-term fluctuations in PV generation (e.g. fast-moving cloud covers the island or feeder fault). This battery bank and its large inverter will lead the system with regards to frequency stability, through the 11 kV backbone. The revised generator control systems will therefore synchronise to the inverter’s frequency reference.
- f) It is possible that wind generation will be included as implementation proceeds. Size and location are still to be determined. Community consultation in respect to location will be necessary. For a total rated output of 1000 kWp, a possible concept is for two wind farms rated 500 kWp each, one located at the southern end of Fogafale, the other on the northern end. The wind farms could comprise a number of turbines, probably sized between 20 and 50 kWp with nacelle heights in the order of 25 metres. The ultimate size selection will be determined taking into account maintainability factors. One option to be considered is for wind turbines to be installed on adjacent islets or on the reefs between the islets, however, economic, environmental and cultural issues would need to be considered.
- g) The wind turbine generators will be “stringed up” on DC or AC and feed into a battery bank. The batteries will buffer electricity fluctuations caused by gusts or faults and are needed to facilitate grid stability. The batteries will be connected via inverters directly to the 11 kV grid via a transformer.
- h) As discussed previously in this Master Plan, to provide additional wind data and TEC with operating and maintenance experience, it is recommended that a single 20kWp turbine be installed on Funafuti in 2013, perhaps near the power station.



# Appendix B

## Grid Issues

**Figure B-1 Stage 1, Existing Funafuti System with 40 kWp grid connected PV array**

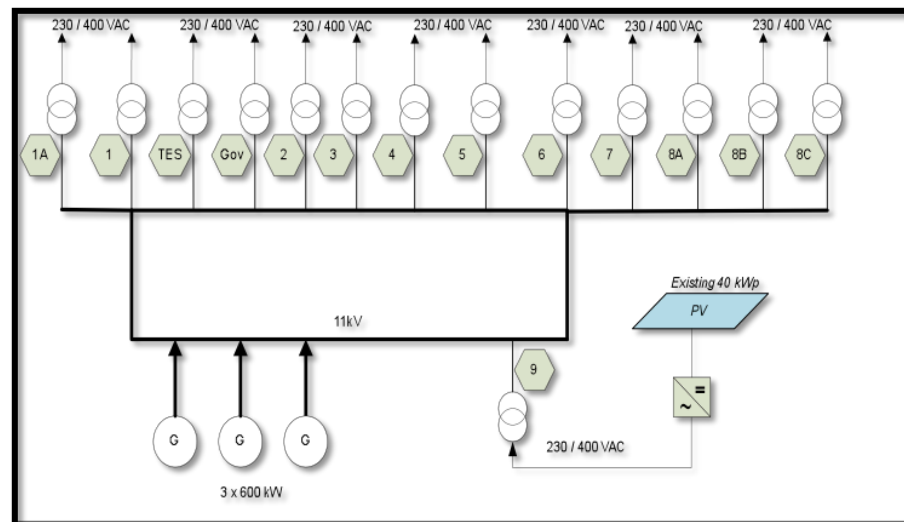

The distribution network consists of an 11 kV three phase ring main with single branches south and north respectively in accordance with the geography of the island. Off this 11 kV system, 14 transformers convert to LV at 230 / 400 VAC. The ratings of these transformers are shown in Table B1 over.

Figures B-3 and B-4 over are (respectively) schematics of (a) decentralised, synchronised PV clusters on Funafuti, PV only (Stage 2) and (b) decentralised, synchronised PV clusters on Funafuti, PV plus grid-connected wind generation.

**Table B-1 Fogafale network transformers**

No.	Location/Name	Rating in kVA	Peak Loads in kVA
1A	Kavatoetoe	100	18
1	Philatelic	160	Not available
TES	Essential Services	200	32
Gov	Government	500	207
2	Faimalaga	150	95
3	Lota	200	113
4	Semu	200	130
5	TCS	63	37
6	Fisheries	400	106
7	Laisini	100	14
8	Matalagi	100	9.5
8A	Fetuvalu	160	Not available
8B	Te Ausaga Tapaka	100	Not available
9	Meteorological	200	65





## Appendix B

# Grid Issues

### Communication Systems

With a number of de-centralised generation systems dispersed throughout Funafuti and on the other eight Outer Islands, an internet based system that will enable TEC to monitor the performance of the main components of all the systems is essential.

The systems will be developed over time as part of the renewable electricity programme implementation, starting with trials on Funafuti and then moving to the Outer Islands. TEC is working with TTC to establish an adequate level of connectivity between the Outer Islands and TEC in Funafuti.

**Figure B-2** Communication system schematic

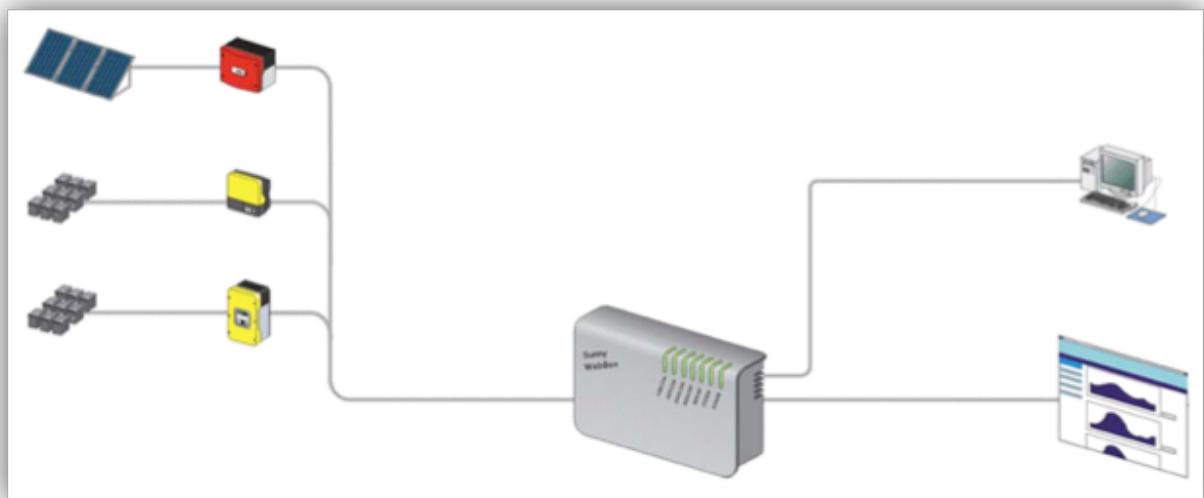

Source: SMA



# Appendix B

## Grid Issues

Figure B-3 Stage 2, Decentralised, synchronised PV Clusters on Funafuti, PV solar only

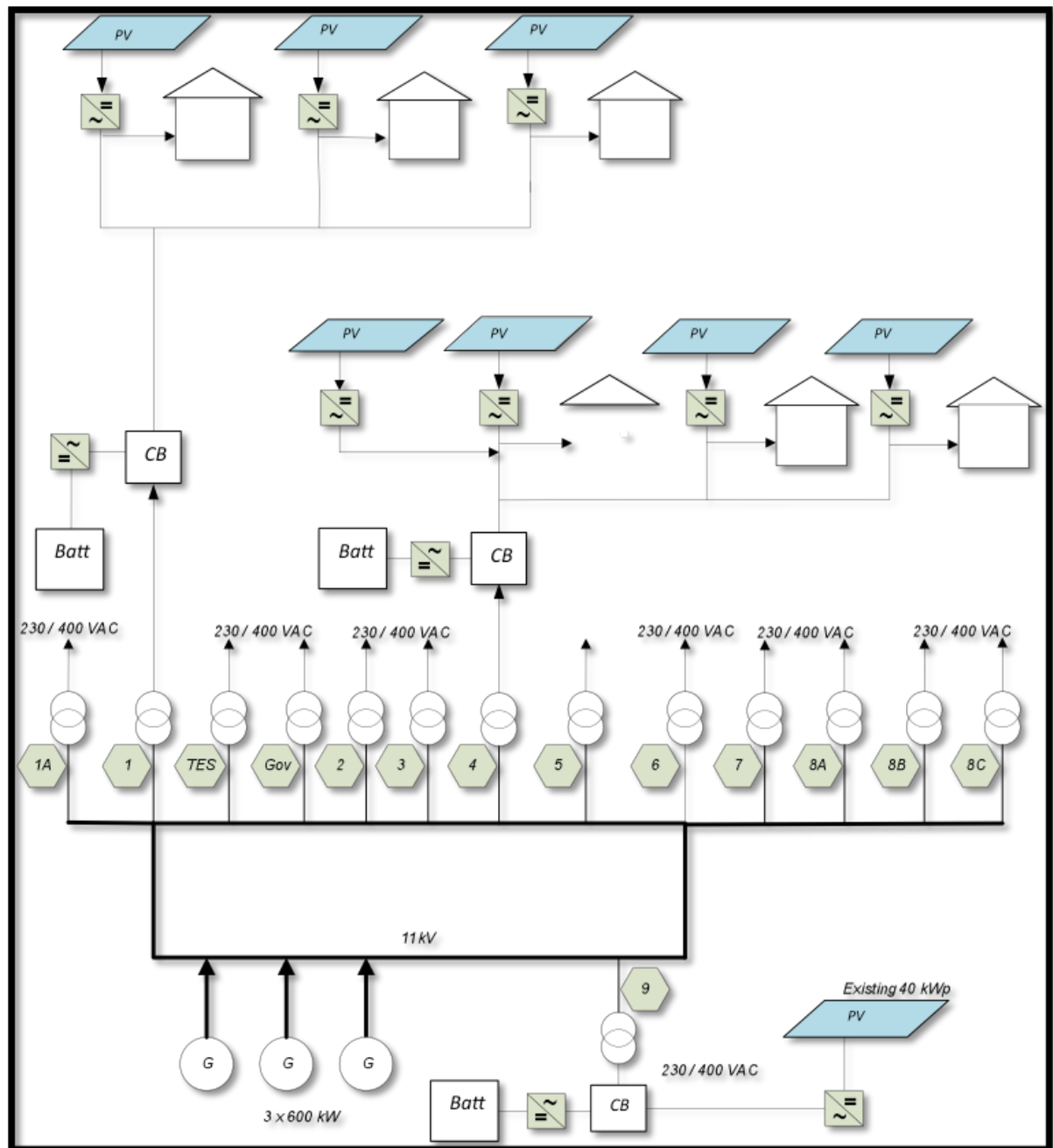



# Appendix B

## Grid Issues

Figure B-4 Stage 3, Decentralised, synchronised PV Clusters on Funafuti, PV solar and grid-connected Wind power.

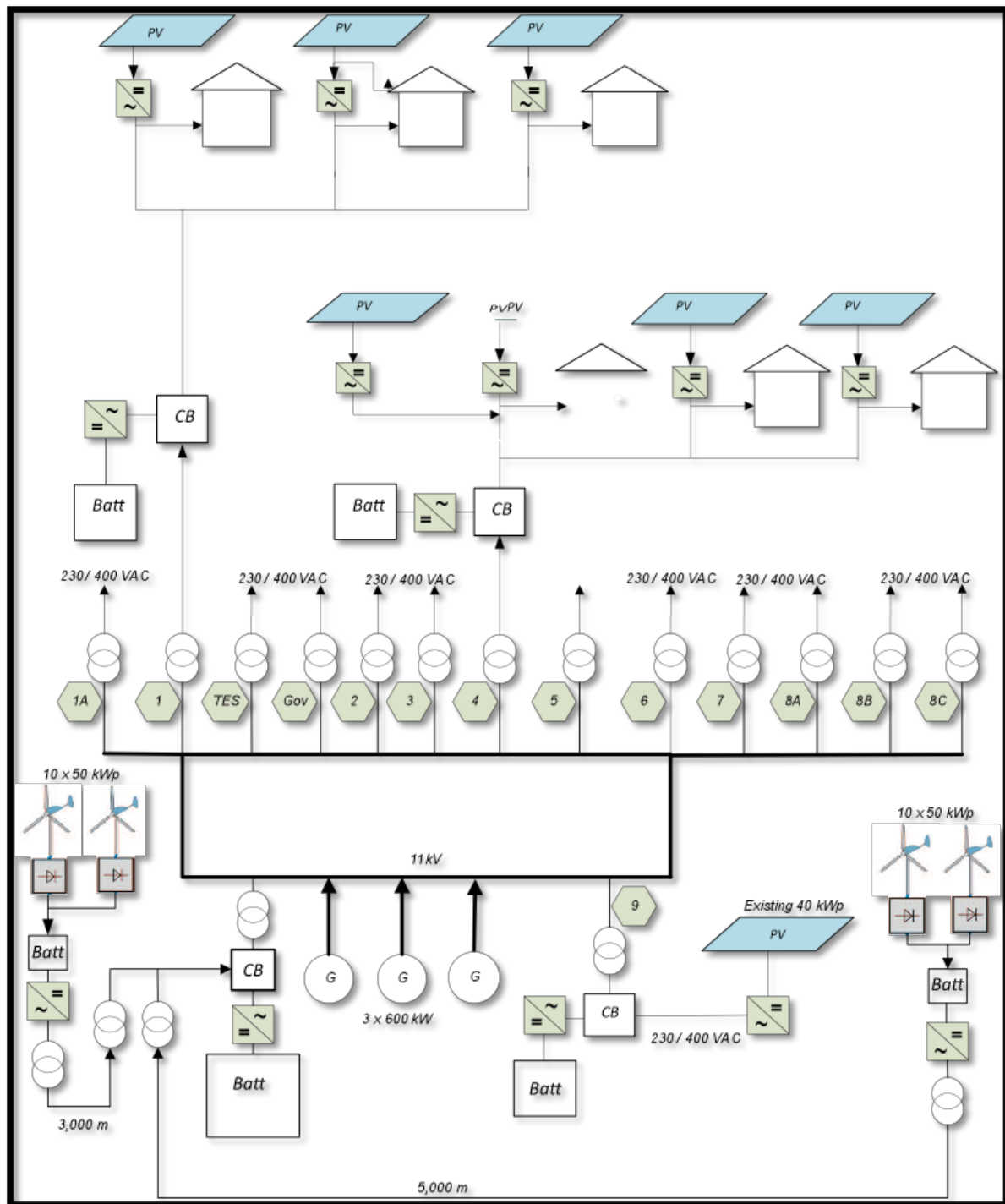





## Appendix B

### Grid Issues

#### Existing Distribution Losses

A 2011 report by KEMA International B.V. established that distribution losses in Tuvalu are less significant than earlier reported and are similar to those in other similar countries. The reasons for this (better than the initially assumed performance) are:

- a) A large part of the “losses” were caused by unmetered street lighting.
- b) The distribution systems are relatively young with most network assets dating back 10 years, when systems were upgraded with new central generators and network components thanks to Tuvalu’s inflow of capital through the tv-campaign.

KEMA estimated losses as follows:

	kWh	% of generation	% of system consumption
annual generation power plant	5,394,652		
annual generation solar power	65,179		
total annual energy produced	5,459,831		
annual station auxiliary	471,152	8.63%	
office usage	137,122	2.51%	
annual system consumption	4,851,557	88.86%	
annual energy sold	4,406,445	80.71%	90.83%
system loss including unbilled usage	445,112	8.15%	9.17%
unbilled usage	54,598	1.00%	1.13%
technical loss	197,647	3.62%	4.07%
non tech loss	192,866	3.53%	3.98%

KEMA also made the following observations in regard to technical losses:

- a) TEC has only 15 distribution transformers, but these represent a total installed capacity of 3030 kVA (an average of over 200kVA per transformer). The results show that distribution transformer losses accounted for 38.08% of the annual technical losses, with 30.05% as no-load (core) loss and 8.03% as copper loss.



## Appendix B

### Grid Issues

b) Using 15 distribution transformers to serve 1018 customers yields an average of 72 customers per distribution transformer. This is a large number of customers per transformer and results in relatively high secondary wire losses, which include losses through the main cable (the secondary cable connecting the distribution transformer to the feeder pillar), the secondary line (the secondary cable connecting the feeder pillar to the service pillar), and the LV secondary cable and service drop. However, since the main cable and LV secondary line are three phase, losses are relatively low when compared to single phase connections serving the same amount of load. KEMA estimates that secondary losses represent 57.46% of the TEC annual technical losses.



*Photo: KEMA*

#### **Revenue Collection**

Revenue collection level is generally good but improvements are possible. The installation of smart meters as discussed in 6.4 above will assist in this regard. An improved billing management system is planned including the setting up of a communication system with TEC offices on the Outer Islands.

## Appendix C



# Renewable Energy Projects





## Appendix C

# Renewable Energy Projects

### Renewable Energy Projects

The Renewable Energy projects completed up to and including 2012 and planned for 2013 with secured funding are listed below:

- a) 40 kWp grid connected PV- Funafuti, 2008. E8 funded
- b) Wind Resource Testing, Funafuti, 2009 – 2010;
- c) 46 kWp hybrid PV/diesel/battery- Vaitupu, 2010. Italy/Austria funded.
- d) 66 kWp grid connected PV (with Hitachi RO Desalination Plant) - Funafuti, 2012/13. PEC funded
- e) 4 kWp on REEE Demonstration Fale – Funafuti, 2013. UNDP (SIDS-DOCK) funded.
- f) 40 kWp grid connected PV -Funafuti, 2012. Russia-funded
- g) 9kWp stand-alone solar PV desalination plant, 2012. AUSAid/UK/USA funded.

### 110 kWp Project 2012

One of the projects planned for 2012, but now delayed, was a co-funded project for 110 kWp PV solar with battery backing on three Outer Islands, Nukulaelae, Nukufetau and Nui, plus a demonstration PV array at TMTI on Amatuku Island. Arrangements for co-funding from a number of donors are under discussion. Estimated cost is in the order of € 2.5 million.



## Appendix D

# Tuvalu Electricity Corporation Data



## Appendix D

# Tuvalu Electricity Corporation Data

### TEC 2010 Data

Tuvalu Electricity Corporation Base Line for Master Plan				
2010				
	Sales	Units	Avg Tariff	Nom
	\$		\$/kWh	
<b>Fogafale</b>				
Government - kWh	\$777,087	1,387,656	\$0.56	
Commercial - kWh	\$781,053	1,394,737	\$0.56	
Private - kWh	\$728,171	1,624,052	\$0.45	
<b>Subtotal / Average</b>	<b>\$2,286,311</b>	<b>4,406,445</b>	<b>\$0.52</b>	
Population		5,156		
Average Demand per Person kWh		855		
No. of connections		1,271		
People per premises (incl commercial)		4.1		
Fuel Used (l)		1,423,277		
Power generated (kWh)		5,394,652		
Power distributed (kWh)		4,860,379		
Generation Efficiency (kWh/l)		3.79		
Dist. Losses / Unaccounted (kWh)		453,934		
Dist. Losses / Unaccounted (%)		9.3%		
Overall Efficiency (kWh/l)		3.10		
<b>Outer Islands</b>				
Govt	\$41,593	75,624	\$0.55	
Commercial	\$66,380	120,691	\$0.55	
Private	\$304,698	803,849	\$0.38	
<b>Subtotal / Average</b>	<b>\$412,671</b>	<b>1,000,164</b>	<b>\$0.41</b>	
Population		5,906		
Average Demand per Person kWh		169		
No. of Connections		1,103		
People per premises (incl commercial)		5.4		
Fuel Used		339,109		
Power generated (kWh)		1,050,000		
Losses / Unaccounted (kWh)		49,836		
Losses / Unaccounted (%)		4.7%		
Generation Efficiency (kWh/l)		3.10		
Overall Efficiency (kWh/l)		2.95		
<b>Total Sales</b>	<b>\$2,698,983</b>	<b>5,406,609</b>	<b>\$0.50</b>	
<b>Total No. of Connections</b>		<b>2,374</b>		
Annual Growth of connections		8.0%		
Total Population		11,062		
Demand per Person kWh		489		
<b>Total Energy Generated (kWh)</b>		<b>6,444,652</b>		
<b>Total Energy Send Out (kWh)</b>		<b>5,678,508</b>		
<b>Losses / unaccounted for (kWh)</b>		<b>271,899</b>		
<b>Losses / unaccounted for %</b>		<b>4.8%</b>		
<b>TEC Expenditure</b>				
2010				
AUD				
Fuel costs		2,427,365		
Personnel expenses		772,094		
Doubtful debts expense		699,379		
Depreciation		964,226		
Impairment (Asset Value Adjustments)		726,559		
Other operating expenses		586,645		
<b>Total Expenses</b>		<b>6,211,105</b>		
Cost per kWh (total 2010)		\$1.15		
<b>Cost per kWh (excl write offs)</b>		<b>\$0.97</b>		



## Appendix D

# Tuvalu Electricity Corporation Data

### Funafuti Generators

Funafuti has three operational generators with ratings of 600 kW each. These generators were donated by Japan in 2006 and are now (in 2012) due for their first major overhaul. This power station runs 24 hours a day and has typical loads of 900 kW during the day, peaking at 1000 kW, and about 500 kW at night, dropping to about 400 kW. TEC's head office is located at the power station.

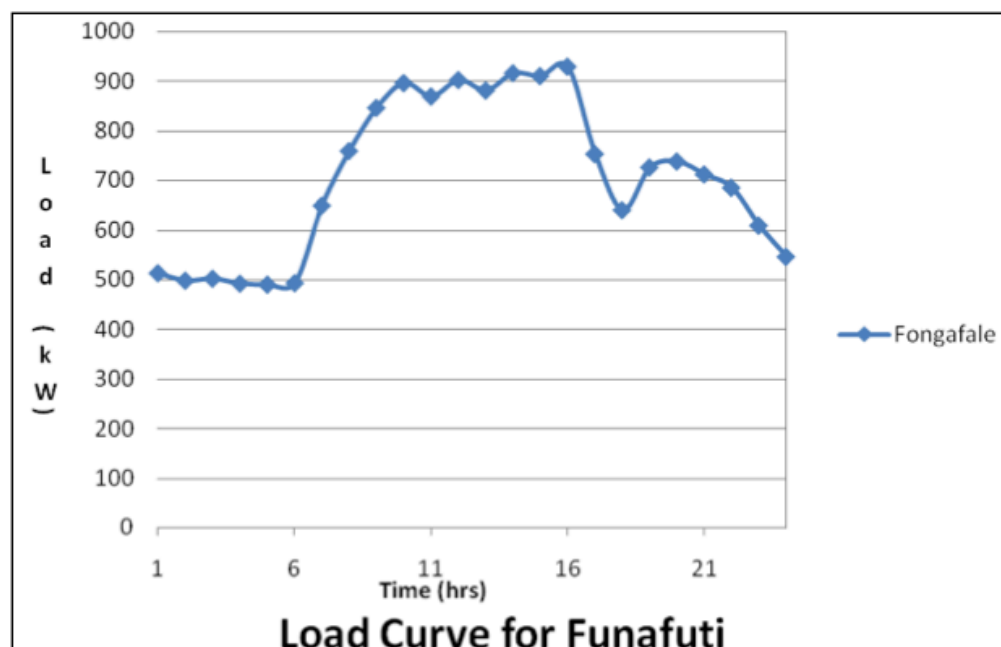

Source: KEMA





## Appendix D

# Tuvalu Electricity Corporation Data

### TEC Renewable Energy Master Plan 2009-2018

*Extract from the REEEU Final Report*

**TUVALU ELECTRICITY CORPORATION**  
**10 YEARS RENEWABLE ENERGY MASTER PLAN**  
**JANUARY 2009-DECEMBER 2018**



- 1) TEC's fuel consumptions to reduce at the following levels:
  - 3% per annum in 2009 – 2010
  - 7% from 2011-2013
  - 12% per annum until the end of 2018
- 2) The TEC's Master Plan is inline with the Government Vision for Tu-8 to be 100% Renewable Energy by 2020 for all it's Power Generation.
- 3) 2008 Total CO<sup>2</sup> – 4,537tons from 1,586,925ltrs consumed in 2008.
- 4) **Major Component of the MP:**
  - COMPONENT 1 - Implement a Loss Reduction Program (Study Completed-funded by NZ Government)**
    - Network Loss no greater than 6%
    - Generation loss a target of 2%
  - COMPONENT 2 – Develop education campaign in combination with an investment incentive program design to reduce consumer demand.**
    - target 4% per annum reduction in household consumption
  - COMPONENT 3 – Solar PV Installations would be planned for and commissioned**
    - target of 1MW by 2018
  - COMPONENT 4 – Plan and Install Wind Turbines across Funafuti and as appropriate in the Outer islands**
    - 40kW turbine by 2010 and 2 installed 2011 with further 2 each year until 2018
    - (In the case of Vanuatu, one pilot wind turbine was installed for 1year and monitors its performance. Analysis was carried out and found to be feasible).
  - COMPONENT 5 – To Identify options for generating electricity at night or at other times when there is insufficient renewable power being generated including batteries and biofuel**
    - 50tonnes of Jatropha is harvested and processed in 2011 with plant production rising to 700tonnes by 2018.
    - It is worth trying, as in Vanuatu's experience with biofuel, starts with 5% and gradually increases, now is at 30% coconut oil. They face lots of problems when started and they able to rectify those problems.



## Appendix D

# Tuvalu Electricity Corporation Data

### Tuvalu Electricity Corporation Developed Renewable Energy Projects Update

No	Projects	Comments
1	Recruitment of the Renewable Energy & Energy Efficiency TA	<p>i) The newly establishment Renewable Energy &amp; Energy Efficiency Unit (REEEU) has been approved by the TEC Board. The unit is now manned with one staff.</p> <p>ii) The TA is :            - to physically establish the unit            - to implement the 10years Master Plan            - to train and build the capacity of TEC staff for an eventual take over after 2 years            - to draw up funding proposals for RE and EE installations and activities in Tuvalu            - to provide advise to TEC management on a long term sustainability and effectiveness of the REEU.</p> <p>iii) Submitted project proposal to REEEP (Renewable Energy and Energy Efficiency Partnership) and the proposal was on the wait-listed.</p> <p>iv) I have contacted REEEP for an updates and have not received any response.</p>
2	Fogafale 40Kw Grid Connected Project 	<p>i) The project has been working very well since its commissioning in February 2008.</p> <p>ii) In the 18 months of operation, the project saved 25,075ltrs of diesel fuel, \$41,300 and 71tons of Co<sup>2</sup>.</p> <p>iii) There has been some preliminary findings and the project capacity can be extended to 60kW, 8% of the Fogafale Peak demand.</p>
3	Wind Resource Assessment 	<p>i) In May'09, completed two years of wind assessment for Funafuti Island. It is now planned to continue wind resource assessment at the outer-islands and preferably to start with Niulakita, most southern island of Tuvalu.</p> <p>ii) There has been some preliminary analysis been done by the Loss Reduction Project team, and recommended that small turbines in the order of 10kW is best suited for the average wind speed of 5.56m/s for Fogafale Island.</p> <p>iii) Pacific Island Green Gas Abatement for Renewable Energy Project (PIGGAREP) will provide financial support for the recruitment of a Consultant to analysis the 2 years wind data, provide training on how to analysis data, prepare wind fuel savings project for</p>



## Appendix D

# Tuvalu Electricity Corporation Data

### Tuvalu Electricity Corporation Developed Renewable Energy Projects Update

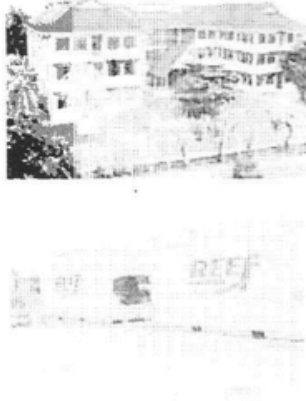
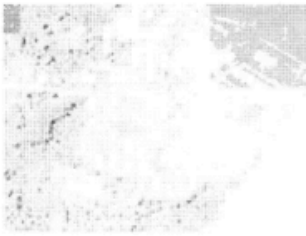
		Fogafale and installing wind resource assessment equipments at Niulakita.
4	<b>Demand Side Management</b> 	<p>i) In Sept'08 TEC embarked on Energy Conservation by requesting Government to switch-off electrical equipments when not in used or after working hours. TCS was also requested for its refrigerated container to switch off during the evening peak hours.</p> <p>ii) The ultimate aim is to reduce the evening peak and for one generator to operate from evening till the next morning.</p> <p>iii) During this 12months, TEC was able to save <u>105,307ltrs</u> of diesel fuel, <u>\$162,004</u> and <u>301tons CO<sub>2</sub></u>.</p>
5	<b>Motufoua 46kW Mini Grid</b> 	<p>i) The project is funded by the Italian Government and is being managed by IUCN-Oceania Regional Office in Suva, Fiji.</p> <p>ii) Project Amount – USD\$800K</p> <p>iii) Anticipated Carbon Footprint – 126tons/annum</p> <p>iv) Construction will commence sometime in Oct'09 and to be completed by the end of Nov'09.</p> <p>v) Contractor – Eco-Kinetics, Australian Based Company.</p>

**Appendix E**



# Extract from Tuvalu National Energy Policy





## Appendix E

# Extract from Tuvalu National Energy Policy

Established: August 2009

Endorsed by Hon. **Kausea Natano**, Minister for Public Utilities and Industries

The following is an extract of the National Energy Policy:

### **Vision**

“By the year 2020 guided by the principles in the “Te Kakeega II” and the “Malefatunga Declaration”, Tuvalu shall attain a prosperous living standard that is fostered through an energy policy that promotes the provision of socially, financially, economically, technically, politically and environmentally sustainable energy systems and [is] within the framework of the Tuvalu Initial National Communication under the United Nations Framework on Climate Change (Oct 1999).”

The following are relevant **extracts** of Tuvalu’s National Energy Policy, where it relates to REEE.

### **Goal**

To improve the well-being of the Tuvalu people by promoting the use of its renewable energy resources and implementing cost effective, equitable, reliable, accessible, affordable, secure and environmentally sustainable energy systems.

### **Principles of Policy**

- a) Sustainability
- b) Gender Equity
- c) Environmental Compatibility
- d) Stakeholder Participation
- e) Good Governance
- f) Cultural and Traditional Compatibility

### **Key Strategic Areas**

*1. Energy Sector Planning, Co-ordination and Management*

*2. Petroleum*

*3. Transport*

*4. Electricity*

*Policies*

- 4.1 Ensure that the Tuvalu Electricity Corporation (TEC) operates as a commercial power utility and is able to provide a cost-effective and reliable electricity supply to meet the electricity demand within Funafuti and the outer islands.
- 4.2 Ensure that all power supply systems in Tuvalu operate with strict adherence to established environmental guidelines
- 4.3 Encourage the use of alternative fuels and renewable energy sources for power generation.

*5. Renewable Energy*

*Policies*

- 5.1 Promote and implement the use of appropriate, proven, affordable and cost-effective renewable energy technologies both for urban and rural applications.
- 5.2 Establish and maintain a knowledge base for all available and appropriate renewable energy sources and technologies.



## Appendix E

# Extract from Tuvalu National Energy Policy

- 5.3 Ensure Tuvalu's limited biomass, copra bio-fuel and other renewable energy resources are used efficiently, in an economically, environmentally and culturally sustainable manner.
- 5.4 Develop local expertise in the installation, operation, management and maintenance of technically and economically proven renewable energy systems.
- 5.5 Develop partnerships with potential foreign and local investors, donors, and agencies in seeking funding sources for the development of renewable energy programmes.
- 5.6 Develop an implementation plan to realise the target of 100% of electricity generation through renewable energy technologies by 2020.

### *6. Energy Conservation and Efficiency Policies*

- 6.1 Promote energy conservation and efficiency programmes in all sectors of the economy.
- 6.2 Ensure that energy conservation and efficiency measures are incorporated in TEC operations including generation, transmission and distribution.
- 6.3 Promote the use of renewable energy as a means to achieve energy efficiency where attainable.
- 6.4 Promote public awareness in conservation and efficiency measures.
- 6.5 Promote the use of energy saving measures including the use of efficient appliances and equipment.
- 6.6 Develop an energy efficiency and energy conservation target to assist in realising the 100% renewable energy target for power generation.